

**AGGO**

**INDUSTRIES INC.**

**Manufacturers of  
Industrial Safety Products**



## **INDUSTRIES INC.**

PO Box 7132  
London, Ontario  
N5Y 4J9

Tel: (519) 452-3780  
Fax: (519) 452-3053

### Introduction and a Word of Thanks

We are now in our 49<sup>th</sup> year of service to the Canadian Industrial Safety Market.

This catalogue has been designed for ease of use and simplicity.

We provide many services beyond the scope of this catalogue and we invite your inquiries on any application in the industrial textile field.

Our mission is to provide quality products at competitive prices with prompt and courteous service.

Thank you for your confidence in our products and our company.

AGO INDUSTRIES INC.



### General Terms and Conditions

1. All products and prices are quoted FOB our London, ON manufacturing facility.
2. All taxes are extra, if applicable.
3. Our terms are Net 30 Days OAC, or we accept VISA, MC and AMEX.

**Manufacturers of Industrial Safety Products**



**INDUSTRIES INC.**

PO Box 7132  
London, Ontario  
N5Y 4J9

Tel: (519) 452-3780  
Fax: (519) 452-3053

# Table of Contents

- Introduction and Terms ..... 1
- Portable Safety Screens ..... 3
  - 'See Thru' Vinyl Screens ..... 5
  - Cotton Duck Screens ..... 12
  - Vinyl-Poly Screens ..... 13
- Curtain and Screen Accessories ..... 14
- Safety Curtains ..... 15
  - 'See Thru' Vinyl Curtains ..... 15
  - Cotton Duck Curtains and Blankets ..... 26
  - Vinyl-Poly Curtains ..... 29
  - Neony Curtains and Covers ..... 32
  - Heatstop Curtains ..... 38
  - Aluminized Aramid Curtains ..... 49
- Welding/Safety Blankets ..... 33
  - Goldengard Blankets ..... 33
  - Aramid Blankets ..... 35
  - Weldflex Blankets ..... 36
  - Carbon Felt Blankets ..... 37
  - Agotex Blankets ..... 39
  - Agotex Plus Blankets ..... 45
  - Ago-Sil Blankets ..... 47
- Emergency Fire Blankets ..... 50
- Mig and Tig Cable Cover ..... 52
- Track and Hardware ..... 54
- Safety/Welding Strip Curtains & Doors ..... 57
- High Heat Gloves & Mitts ..... 63
- Flame Resistant Clothing ..... 65
  - FR Cotton Garments ..... 66
  - Aluminized Rayon Garments ..... 70
  - Aluminized Preox® Garments ..... 71
  - Aluminized Aramid Garments ..... 72
  - Aluminized Aramid/Carbon Garments ..... 73
- Roll Goods ..... 74

# AGO

INDUSTRIES INC.

# PORTABLE SAFETY SCREENS

One, two, three, & four Panel  
Safety Screens for  
Welding Booths, Grinding  
Shields, Draft Barriers,  
Machine Enclosures, Privacy  
Enclosures, Dividing Partitions,  
& Noise and Heat Barriers.



# PORTABLE SAFETY SCREENS



**ONE PANEL**



**TWO PANEL**



**THREE PANEL**



**FOUR PANEL**

Model	Height	Width	Model	Height	Width	Model	Height	Centre	Wings	Model	Height	Width
# 155	5'	5'	# 253	5'	3'	# 3533	5'	3'	3'	# 453	5'	3'
# 157	5'	7'	# 255	5'	5'	# 3544	5'	4'	4'	# 455	5'	5'
# 159	5'	9'	# 257	5'	7'	# 3555	5'	5'	5'	# 457	5'	7'
# 1510	5'	10'	# 264	6'	4'	# 3564	5'	6'	4'	# 459	5'	9'
# 166	6'	6'	# 266	6'	6'	# 3644	6'	4'	4'	# 464	6'	4'
# 168	6'	8'	# 268	6'	8'	# 3666	6'	6'	6'	# 466	6'	6'
# 1610	6'	10'	# 2610	6'	10'	# 3686	6'	8'	6'	# 4610	6'	10'

*\*Note - Height & Width shown is of each Panel Curtain. Other Frame Sizes Available - Casters are an optional extra.*

## AGO PORTABLE SAFETY SCREENS

The AGO portable lightweight frame is constructed of plated, corrosion resistant, heavy duty tubular steel consisting of slip joint design with easy press spring locks for simple and adjustable assembly. Support legs are adjustable spring lock design that allows the legs to be folded parallel to screen for compact storage. Sturdy plated hinges permit easy folding for compact storage and handling on two, three and four panel models. Heavy duty plated frame hooks secure curtains to frames. Heavy duty casters are available as an optional extra on all models.

*AGO Curtain Fabrics are chosen to best suit job application.*

## FR FLEXIBLE SEE/THRU VINYL CURTAINS

The yellow, orange, blue, combo yellow/green, green, and shade 8 vinyls exceed OSHA specifications for screening or enclosing Stick, MIG and TIG welding operations. Clear 'See Thru' vinyl allows 100% visibility for screening where welding flash does not exist. THESE 'SEE THRU' CURTAINS - ISOLATE WELDING AREAS - PROTECT ADJACENT WORKERS - INCREASE PRODUCTION WHEN WORK CAN BE SEEN IN PROGRESS - PROVIDE SAFETY AND IMMEDIATE ATTENTION FOR INJURED WORKERS. THE HEAVY DUTY YELLOW, ORANGE, BLUE, COMBO YELLOW/GREEN, GREEN AND SHADE 8 TRANSPARENT VINYL FABRICS CONTAIN A SPECIAL FORMULATION WHICH ABSORBS DANGEROUS ULTRA-VIOLET RADIATION AND PROTECTS CO-WORKERS FROM EYE FLASH BURNS.

The specially treated vinyl curtains meet all requirements of the California State Fire Marshal and the CPAI for flame resistance. All vinyl curtains are fabricated with electronically welded seams and hems for greater strength and life expectancy. Vinyl grommets are electronically sealed into double hems on 12" centers, allowing the grommet to become an integral part of the curtain.

## FR FLEXIBLE NON SEE/THRU CURTAINS

Opaque safety screen curtains are offered in a number of fabrics chosen for particular conditions - such as heavy abrasion, moisture, high-temperature, etc. These curtains include ambient temperature fabrics - cotton duck, vinyl coated polyester and neoprene coated nylon, and higher temperature fabrics including Fibreglass cloths, both coated and uncoated, and a variety of aramid cloths.

These opaque curtains have sewn seams and hems. Threads are selected to be compatible with the curtain fabrics. Metal grommets are installed in the hems on 12" centers.



PO Box 7132  
London, Ontario  
N5Y 4J9

Ph: (519) 452-3780  
Fx: (519) 452-3053

Distributed By:

Manufacturers of Industrial Safety Products

## Portable Safety Screens

### Yellow 'See Thru' Vinyl

See Fabric # 001

#### One Panel Model



Item #	Height	Width	Price
SC-001-153	5'	3'	\$ 137.45
SC-001-154	5'	4'	\$ 152.25
SC-001-155	5'	5'	\$ 165.05
SC-001-156	5'	6'	\$ 184.05
SC-001-157	5'	7'	\$ 202.75
SC-001-158	5'	8'	\$ 218.20
SC-001-159	5'	9'	\$ 236.90
SC-001-1510	5'	10'	\$ 252.00
SC-001-166	6'	6'	\$ 202.75
SC-001-167	6'	7'	\$ 226.05
SC-001-168	6'	8'	\$ 244.75
SC-001-169	6'	9'	\$ 263.80
SC-001-1610	6'	10'	\$ 282.15

\* Optional Casters #CG-005-1 \$ 31.50

#### Two Panel Model

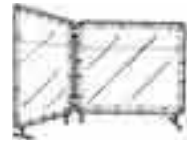

Item #	Height	Wings	Price
SC-001-253	5'	3'	\$ 244.75
SC-001-254	5'	4'	\$ 271.00
SC-001-255	5'	5'	\$ 296.95
SC-001-256	5'	6'	\$ 323.50
SC-001-257	5'	7'	\$ 342.55
SC-001-258	5'	8'	\$ 361.25
SC-001-263	6'	3'	\$ 267.10
SC-001-264	6'	4'	\$ 289.40
SC-001-265	6'	5'	\$ 323.50
SC-001-266	6'	6'	\$ 346.15
SC-001-268	6'	8'	\$ 387.50
SC-001-269	6'	9'	\$ 411.10
SC-001-2610	6'	10'	\$ 432.80

\* Optional Casters #CG-005-2 \$ 47.25

#### Three Panel Model

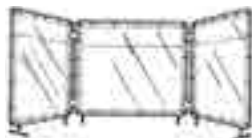

Item #	Height	Centre	Wings	Price
SC-001-3533	5'	3'	3'	\$ 353.35
SC-001-3543	5'	4'	3'	\$ 364.85
SC-001-3544	5'	4'	4'	\$ 376.35
SC-001-3555	5'	5'	5'	\$ 417.70
SC-001-3563	5'	6'	3'	\$ 376.35
SC-001-3564	5'	6'	4'	\$ 402.60
SC-001-3566	5'	6'	6'	\$ 440.00
SC-001-3588	5'	8'	8'	\$ 496.75
SC-001-3633	6'	3'	3'	\$ 368.45
SC-001-3644	6'	4'	4'	\$ 414.40
SC-001-3655	6'	5'	5'	\$ 440.00
SC-001-3666	6'	6'	6'	\$ 481.35
SC-001-3686	6'	8'	6'	\$ 511.55
SC-001-3688	6'	8'	8'	\$ 541.40

\* Optional Casters #CG-005-3 \$ 63.00

#### Four Panel Model

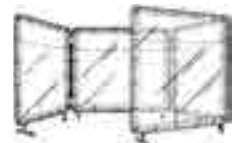

Item #	Height	Wings	Price
SC-001-453	5'	3'	\$ 474.10
SC-001-454	5'	4'	\$ 511.85
SC-001-455	5'	5'	\$ 553.20
SC-001-456	5'	6'	\$ 590.60
SC-001-457	5'	7'	\$ 621.10
SC-001-458	5'	8'	\$ 654.25
SC-001-459	5'	9'	\$ 687.40
SC-001-4510	5'	10'	\$ 718.90
SC-001-464	6'	4'	\$ 542.70
SC-001-465	6'	5'	\$ 590.60
SC-001-466	6'	6'	\$ 654.25
SC-001-468	6'	8'	\$ 748.45
SC-001-469	6'	9'	\$ 788.80
SC-001-4610	6'	10'	\$ 826.85

\* Optional Casters #CG-005-4 \$ 78.75



# Portable Safety Screens

## Orange 'See Thru' Vinyl

See Fabric # 002

### One Panel Model



Item #	Height	Width	Price
SC-002-153	5'	3'	\$ 137.45
SC-002-154	5'	4'	\$ 152.25
SC-002-155	5'	5'	\$ 165.05
SC-002-156	5'	6'	\$ 184.05
SC-002-157	5'	7'	\$ 202.75
SC-002-158	5'	8'	\$ 218.20
SC-002-159	5'	9'	\$ 236.90
SC-002-1510	5'	10'	\$ 252.00
SC-002-166	6'	6'	\$ 202.75
SC-002-167	6'	7'	\$ 226.05
SC-002-168	6'	8'	\$ 244.75
SC-002-169	6'	9'	\$ 263.80
SC-002-1610	6'	10'	\$ 282.15

\* Optional Casters #CG-005-1 \$ 31.50

### Two Panel Model

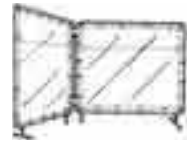

Item #	Height	Wings	Price
SC-002-253	5'	3'	\$ 244.75
SC-002-254	5'	4'	\$ 271.00
SC-002-255	5'	5'	\$ 296.95
SC-002-256	5'	6'	\$ 323.50
SC-002-257	5'	7'	\$ 342.55
SC-002-258	5'	8'	\$ 361.25
SC-002-263	6'	3'	\$ 267.10
SC-002-264	6'	4'	\$ 289.40
SC-002-265	6'	5'	\$ 323.50
SC-002-266	6'	6'	\$ 346.15
SC-002-268	6'	8'	\$ 387.50
SC-002-269	6'	9'	\$ 411.10
SC-002-2610	6'	10'	\$ 432.80

\* Optional Casters #CG-005-2 \$ 47.25

### Three Panel Model

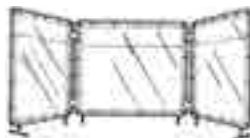

Item #	Height	Centre	Wings	Price
SC-002-3533	5'	3'	3'	\$ 353.35
SC-002-3543	5'	4'	3'	\$ 364.85
SC-002-3544	5'	4'	4'	\$ 376.35
SC-002-3555	5'	5'	5'	\$ 417.70
SC-002-3563	5'	6'	3'	\$ 376.35
SC-002-3564	5'	6'	4'	\$ 402.60
SC-002-3566	5'	6'	6'	\$ 440.00
SC-002-3588	5'	8'	8'	\$ 496.75
SC-002-3633	6'	3'	3'	\$ 368.45
SC-002-3644	6'	4'	4'	\$ 414.40
SC-002-3655	6'	5'	5'	\$ 440.00
SC-002-3666	6'	6'	6'	\$ 481.35
SC-002-3686	6'	8'	6'	\$ 511.55
SC-002-3688	6'	8'	8'	\$ 541.40

\* Optional Casters #CG-005-3 \$ 63.00

### Four Panel Model

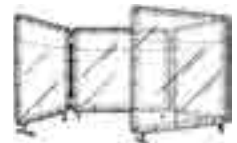

Item #	Height	Wings	Price
SC-002-453	5'	3'	\$ 474.10
SC-002-454	5'	4'	\$ 511.85
SC-002-455	5'	5'	\$ 553.20
SC-002-456	5'	6'	\$ 590.60
SC-002-457	5'	7'	\$ 621.10
SC-002-458	5'	8'	\$ 654.25
SC-002-459	5'	9'	\$ 687.40
SC-002-4510	5'	10'	\$ 718.90
SC-002-464	6'	4'	\$ 542.70
SC-002-465	6'	5'	\$ 590.60
SC-002-466	6'	6'	\$ 654.25
SC-002-468	6'	8'	\$ 748.45
SC-002-469	6'	9'	\$ 788.80
SC-002-4610	6'	10'	\$ 826.85

\* Optional Casters #CG-005-4 \$ 78.75

## Portable Safety Screens

### Blue 'See Thru' Vinyl

See Fabric # 003

#### One Panel Model



Item #	Height	Width	Price
SC-003-153	5'	3'	\$ 137.45
SC-003-154	5'	4'	\$ 152.25
SC-003-155	5'	5'	\$ 165.05
SC-003-156	5'	6'	\$ 184.05
SC-003-157	5'	7'	\$ 202.75
SC-003-158	5'	8'	\$ 218.20
SC-003-159	5'	9'	\$ 236.90
SC-003-1510	5'	10'	\$ 252.00
SC-003-166	6'	6'	\$ 202.75
SC-003-167	6'	7'	\$ 226.05
SC-003-168	6'	8'	\$ 244.75
SC-003-169	6'	9'	\$ 263.80
SC-003-1610	6'	10'	\$ 282.15

\* Optional Casters #CG-005-1 \$ 31.50

#### Two Panel Model

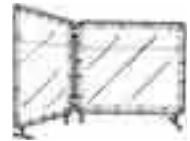

Item #	Height	Wings	Price
SC-003-253	5'	3'	\$ 244.75
SC-003-254	5'	4'	\$ 271.00
SC-003-255	5'	5'	\$ 296.95
SC-003-256	5'	6'	\$ 323.50
SC-003-257	5'	7'	\$ 342.55
SC-003-258	5'	8'	\$ 361.25
SC-003-263	6'	3'	\$ 267.10
SC-003-264	6'	4'	\$ 289.40
SC-003-265	6'	5'	\$ 323.50
SC-003-266	6'	6'	\$ 346.15
SC-003-268	6'	8'	\$ 387.50
SC-003-269	6'	9'	\$ 411.10
SC-003-2610	6'	10'	\$ 432.80

\* Optional Casters #CG-005-2 \$ 47.25

#### Three Panel Model

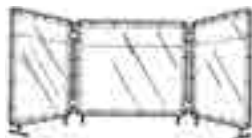

Item #	Height	Centre	Wings	Price
SC-003-3533	5'	3'	3'	\$ 353.35
SC-003-3543	5'	4'	3'	\$ 364.85
SC-003-3544	5'	4'	4'	\$ 376.35
SC-003-3555	5'	5'	5'	\$ 417.70
SC-003-3563	5'	6'	3'	\$ 376.35
SC-003-3564	5'	6'	4'	\$ 402.60
SC-003-3566	5'	6'	6'	\$ 440.00
SC-003-3588	5'	8'	8'	\$ 496.75
SC-003-3633	6'	3'	3'	\$ 368.45
SC-003-3644	6'	4'	4'	\$ 414.40
SC-003-3655	6'	5'	5'	\$ 440.00
SC-003-3666	6'	6'	6'	\$ 481.35
SC-003-3686	6'	8'	6'	\$ 511.55
SC-003-3688	6'	8'	8'	\$ 541.40

\* Optional Casters #CG-005-3 \$ 63.00

#### Four Panel Model

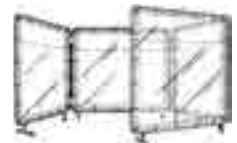

Item #	Height	Wings	Price
SC-003-453	5'	3'	\$ 474.10
SC-003-454	5'	4'	\$ 511.85
SC-003-455	5'	5'	\$ 553.20
SC-003-456	5'	6'	\$ 590.60
SC-003-457	5'	7'	\$ 621.10
SC-003-458	5'	8'	\$ 654.25
SC-003-459	5'	9'	\$ 687.40
SC-003-4510	5'	10'	\$ 718.90
SC-003-464	6'	4'	\$ 542.70
SC-003-465	6'	5'	\$ 590.60
SC-003-466	6'	6'	\$ 654.25
SC-003-468	6'	8'	\$ 748.45
SC-003-469	6'	9'	\$ 788.80
SC-003-4610	6'	10'	\$ 826.85

\* Optional Casters #CG-005-4 \$ 78.75



## Portable Safety Screens

### Green 'See Thru' Vinyl

See Fabric # 004

#### One Panel Model



Item #	Height	Width	Price
SC-004-153	5'	3'	\$ 137.45
SC-004-154	5'	4'	\$ 152.25
SC-004-155	5'	5'	\$ 165.05
SC-004-156	5'	6'	\$ 184.05
SC-004-157	5'	7'	\$ 202.75
SC-004-158	5'	8'	\$ 218.20
SC-004-159	5'	9'	\$ 236.90
SC-004-1510	5'	10'	\$ 252.00
SC-004-166	6'	6'	\$ 202.75
SC-004-167	6'	7'	\$ 226.05
SC-004-168	6'	8'	\$ 244.75
SC-004-169	6'	9'	\$ 263.80
SC-004-1610	6'	10'	\$ 282.15

\* Optional Casters #CG-005-1 \$ 31.50

#### Two Panel Model

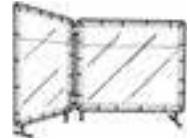

Item #	Height	Wings	Price
SC-004-253	5'	3'	\$ 244.75
SC-004-254	5'	4'	\$ 271.00
SC-004-255	5'	5'	\$ 296.95
SC-004-256	5'	6'	\$ 323.50
SC-004-257	5'	7'	\$ 342.55
SC-004-258	5'	8'	\$ 361.25
SC-004-263	6'	3'	\$ 267.10
SC-004-264	6'	4'	\$ 289.40
SC-004-265	6'	5'	\$ 323.50
SC-004-266	6'	6'	\$ 346.15
SC-004-268	6'	8'	\$ 387.50
SC-004-269	6'	9'	\$ 411.10
SC-004-2610	6'	10'	\$ 432.80

\* Optional Casters #CG-005-2 \$ 47.25

#### Three Panel Model

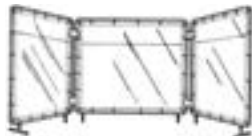

Item #	Height	Centre	Wings	Price
SC-004-3533	5'	3'	3'	\$ 353.35
SC-004-3543	5'	4'	3'	\$ 364.85
SC-004-3544	5'	4'	4'	\$ 376.35
SC-004-3555	5'	5'	5'	\$ 417.70
SC-004-3563	5'	6'	3'	\$ 376.35
SC-004-3564	5'	6'	4'	\$ 402.60
SC-004-3566	5'	6'	6'	\$ 440.00
SC-004-3588	5'	8'	8'	\$ 496.75
SC-004-3633	6'	3'	3'	\$ 368.45
SC-004-3644	6'	4'	4'	\$ 414.40
SC-004-3655	6'	5'	5'	\$ 440.00
SC-004-3666	6'	6'	6'	\$ 481.35
SC-004-3686	6'	8'	6'	\$ 511.55
SC-004-3688	6'	8'	8'	\$ 541.40

\* Optional Casters #CG-005-3 \$ 63.00

#### Four Panel Model

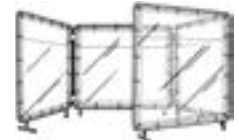

Item #	Height	Wings	Price
SC-004-453	5'	3'	\$ 474.10
SC-004-454	5'	4'	\$ 511.85
SC-004-455	5'	5'	\$ 553.20
SC-004-456	5'	6'	\$ 590.60
SC-004-457	5'	7'	\$ 621.10
SC-004-458	5'	8'	\$ 654.25
SC-004-459	5'	9'	\$ 687.40
SC-004-4510	5'	10'	\$ 718.90
SC-004-464	6'	4'	\$ 542.70
SC-004-465	6'	5'	\$ 590.60
SC-004-466	6'	6'	\$ 654.25
SC-004-468	6'	8'	\$ 748.45
SC-004-469	6'	9'	\$ 788.80
SC-004-4610	6'	10'	\$ 826.85

\* Optional Casters #CG-005-4 \$ 78.75

## Portable Safety Screens

### Shade 8 'See Thru' Vinyl

See Fabric # 005

#### One Panel Model



Item #	Height	Width	Price
SC-005-153	5'	3'	\$ 137.45
SC-005-154	5'	4'	\$ 152.25
SC-005-155	5'	5'	\$ 165.05
SC-005-156	5'	6'	\$ 184.05
SC-005-157	5'	7'	\$ 202.75
SC-005-158	5'	8'	\$ 218.20
SC-005-159	5'	9'	\$ 236.90
SC-005-1510	5'	10'	\$ 252.00
SC-005-166	6'	6'	\$ 202.75
SC-005-167	6'	7'	\$ 226.05
SC-005-168	6'	8'	\$ 244.75
SC-005-169	6'	9'	\$ 263.80
SC-005-1610	6'	10'	\$ 282.15

\* Optional Casters #CG-005-1 \$ 31.50

#### Two Panel Model

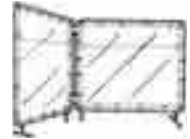

Item #	Height	Wings	Price
SC-005-253	5'	3'	\$ 244.75
SC-005-254	5'	4'	\$ 271.00
SC-005-255	5'	5'	\$ 296.95
SC-005-256	5'	6'	\$ 323.50
SC-005-257	5'	7'	\$ 342.55
SC-005-258	5'	8'	\$ 361.25
SC-005-263	6'	3'	\$ 267.10
SC-005-264	6'	4'	\$ 289.40
SC-005-265	6'	5'	\$ 323.50
SC-005-266	6'	6'	\$ 346.15
SC-005-268	6'	8'	\$ 387.50
SC-005-269	6'	9'	\$ 411.10
SC-005-2610	6'	10'	\$ 432.80

\* Optional Casters #CG-005-2 \$ 47.25

#### Three Panel Model

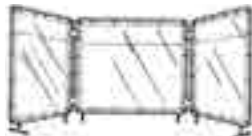

Item #	Height	Centre	Wings	Price
SC-005-3533	5'	3'	3'	\$ 353.35
SC-005-3543	5'	4'	3'	\$ 364.85
SC-005-3544	5'	4'	4'	\$ 376.35
SC-005-3555	5'	5'	5'	\$ 417.70
SC-005-3563	5'	6'	3'	\$ 376.35
SC-005-3564	5'	6'	4'	\$ 402.60
SC-005-3566	5'	6'	6'	\$ 440.00
SC-005-3588	5'	8'	8'	\$ 496.75
SC-005-3633	6'	3'	3'	\$ 368.45
SC-005-3644	6'	4'	4'	\$ 414.40
SC-005-3655	6'	5'	5'	\$ 440.00
SC-005-3666	6'	6'	6'	\$ 481.35
SC-005-3686	6'	8'	6'	\$ 511.55
SC-005-3688	6'	8'	8'	\$ 541.40

\* Optional Casters #CG-005-3 \$ 63.00

#### Four Panel Model

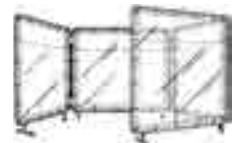

Item #	Height	Wings	Price
SC-005-453	5'	3'	\$ 474.10
SC-005-454	5'	4'	\$ 511.85
SC-005-455	5'	5'	\$ 553.20
SC-005-456	5'	6'	\$ 590.60
SC-005-457	5'	7'	\$ 621.10
SC-005-458	5'	8'	\$ 654.25
SC-005-459	5'	9'	\$ 687.40
SC-005-4510	5'	10'	\$ 718.90
SC-005-464	6'	4'	\$ 542.70
SC-005-465	6'	5'	\$ 590.60
SC-005-466	6'	6'	\$ 654.25
SC-005-468	6'	8'	\$ 748.45
SC-005-469	6'	9'	\$ 788.80
SC-005-4610	6'	10'	\$ 826.85

\* Optional Casters #CG-005-4 \$ 78.75

# Portable Safety Screens

## Combo 'See Thru' Vinyl

See Fabric # 006

### One Panel Model



Item #	Height	Width	Price
SC-006-153	5'	3'	\$ 137.45
SC-006-154	5'	4'	\$ 152.25
SC-006-155	5'	5'	\$ 165.05
SC-006-156	5'	6'	\$ 184.05
SC-006-157	5'	7'	\$ 202.75
SC-006-158	5'	8'	\$ 218.20
SC-006-159	5'	9'	\$ 236.90
SC-006-1510	5'	10'	\$ 252.00
SC-006-166	6'	6'	\$ 202.75
SC-006-167	6'	7'	\$ 226.05
SC-006-168	6'	8'	\$ 244.75
SC-006-169	6'	9'	\$ 263.80
SC-006-1610	6'	10'	\$ 282.15

\* Optional Casters #CG-005-1 \$ 31.50

### Two Panel Model

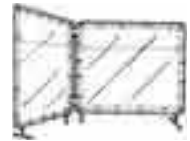

Item #	Height	Wings	Price
SC-006-253	5'	3'	\$ 244.75
SC-006-254	5'	4'	\$ 271.00
SC-006-255	5'	5'	\$ 296.95
SC-006-256	5'	6'	\$ 323.50
SC-006-257	5'	7'	\$ 342.55
SC-006-258	5'	8'	\$ 361.25
SC-006-263	6'	3'	\$ 267.10
SC-006-264	6'	4'	\$ 289.40
SC-006-265	6'	5'	\$ 323.50
SC-006-266	6'	6'	\$ 346.15
SC-006-268	6'	8'	\$ 387.50
SC-006-269	6'	9'	\$ 411.10
SC-006-2610	6'	10'	\$ 432.80

\* Optional Casters #CG-005-2 \$ 47.25

### Three Panel Model

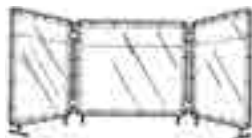

Item #	Height	Centre	Wings	Price
SC-006-3533	5'	3'	3'	\$ 353.35
SC-006-3543	5'	4'	3'	\$ 364.85
SC-006-3544	5'	4'	4'	\$ 376.35
SC-006-3555	5'	5'	5'	\$ 417.70
SC-006-3563	5'	6'	3'	\$ 376.35
SC-006-3564	5'	6'	4'	\$ 402.60
SC-006-3566	5'	6'	6'	\$ 440.00
SC-006-3588	5'	8'	8'	\$ 496.75
SC-006-3633	6'	3'	3'	\$ 368.45
SC-006-3644	6'	4'	4'	\$ 414.40
SC-006-3655	6'	5'	5'	\$ 440.00
SC-006-3666	6'	6'	6'	\$ 481.35
SC-006-3686	6'	8'	6'	\$ 511.55
SC-006-3688	6'	8'	8'	\$ 541.40

\* Optional Casters #CG-005-3 \$ 63.00

### Four Panel Model

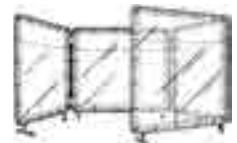

Item #	Height	Wings	Price
SC-006-453	5'	3'	\$ 474.10
SC-006-454	5'	4'	\$ 511.85
SC-006-455	5'	5'	\$ 553.20
SC-006-456	5'	6'	\$ 590.60
SC-006-457	5'	7'	\$ 621.10
SC-006-458	5'	8'	\$ 654.25
SC-006-459	5'	9'	\$ 687.40
SC-006-4510	5'	10'	\$ 718.90
SC-006-464	6'	4'	\$ 542.70
SC-006-465	6'	5'	\$ 590.60
SC-006-466	6'	6'	\$ 654.25
SC-006-468	6'	8'	\$ 748.45
SC-006-469	6'	9'	\$ 788.80
SC-006-4610	6'	10'	\$ 826.85

\* Optional Casters #CG-005-4 \$ 78.75

## Portable Safety Screens

### 16 mil Clear 'See Thru' Vinyl

See Fabric # 007

#### One Panel Model



Item #	Height	Width	Price
SC-007-153	5'	3'	\$ 137.45
SC-007-154	5'	4'	\$ 152.25
SC-007-155	5'	5'	\$ 165.05
SC-007-156	5'	6'	\$ 184.05
SC-007-157	5'	7'	\$ 202.75
SC-007-158	5'	8'	\$ 218.20
SC-007-159	5'	9'	\$ 236.90
SC-007-1510	5'	10'	\$ 252.00
SC-007-166	6'	6'	\$ 202.75
SC-007-167	6'	7'	\$ 226.05
SC-007-168	6'	8'	\$ 244.75
SC-007-169	6'	9'	\$ 263.80
SC-007-1610	6'	10'	\$ 282.15

\* Optional Casters #CG-005-1 \$ 31.50

#### Two Panel Model

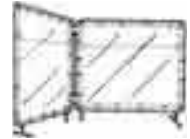

Item #	Height	Wings	Price
SC-007-253	5'	3'	\$ 244.75
SC-007-254	5'	4'	\$ 271.00
SC-007-255	5'	5'	\$ 296.95
SC-007-256	5'	6'	\$ 323.50
SC-007-257	5'	7'	\$ 342.55
SC-007-258	5'	8'	\$ 361.25
SC-007-263	6'	3'	\$ 267.10
SC-007-264	6'	4'	\$ 289.40
SC-007-265	6'	5'	\$ 323.50
SC-007-266	6'	6'	\$ 346.15
SC-007-268	6'	8'	\$ 387.50
SC-007-269	6'	9'	\$ 411.10
SC-007-2610	6'	10'	\$ 432.80

\* Optional Casters #CG-005-2 \$ 47.25

#### Three Panel Model

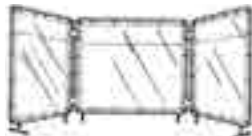

Item #	Height	Centre	Wings	Price
SC-007-3533	5'	3'	3'	\$ 353.35
SC-007-3543	5'	4'	3'	\$ 364.85
SC-007-3544	5'	4'	4'	\$ 376.35
SC-007-3555	5'	5'	5'	\$ 417.70
SC-007-3563	5'	6'	3'	\$ 376.35
SC-007-3564	5'	6'	4'	\$ 402.60
SC-007-3566	5'	6'	6'	\$ 440.00
SC-007-3588	5'	8'	8'	\$ 496.75
SC-007-3633	6'	3'	3'	\$ 368.45
SC-007-3644	6'	4'	4'	\$ 414.40
SC-007-3655	6'	5'	5'	\$ 440.00
SC-007-3666	6'	6'	6'	\$ 481.35
SC-007-3686	6'	8'	6'	\$ 511.55
SC-007-3688	6'	8'	8'	\$ 541.40

\* Optional Casters #CG-005-3 \$ 63.00

#### Four Panel Model

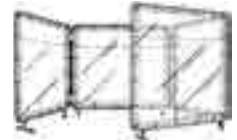

Item #	Height	Wings	Price
SC-007-453	5'	3'	\$ 474.10
SC-007-454	5'	4'	\$ 511.85
SC-007-455	5'	5'	\$ 553.20
SC-007-456	5'	6'	\$ 590.60
SC-007-457	5'	7'	\$ 621.10
SC-007-458	5'	8'	\$ 654.25
SC-007-459	5'	9'	\$ 687.40
SC-007-4510	5'	10'	\$ 718.90
SC-007-464	6'	4'	\$ 542.70
SC-007-465	6'	5'	\$ 590.60
SC-007-466	6'	6'	\$ 654.25
SC-007-468	6'	8'	\$ 748.45
SC-007-469	6'	9'	\$ 788.80
SC-007-4610	6'	10'	\$ 826.85

\* Optional Casters #CG-005-4 \$ 78.75

## Portable Safety Screens

### 10oz Flame Resistant Cotton Duck

See Fabric # 010

#### One Panel Model



Item #	Height	Width	Price
SC-010-153	5'	3'	\$ 137.45
SC-010-154	5'	4'	\$ 152.25
SC-010-155	5'	5'	\$ 165.05
SC-010-156	5'	6'	\$ 184.05
SC-010-157	5'	7'	\$ 202.75
SC-010-158	5'	8'	\$ 218.20
SC-010-159	5'	9'	\$ 236.90
SC-010-1510	5'	10'	\$ 252.00
SC-010-166	6'	6'	\$ 202.75
SC-010-167	6'	7'	\$ 226.05
SC-010-168	6'	8'	\$ 244.75
SC-010-169	6'	9'	\$ 263.80
SC-010-1610	6'	10'	\$ 282.15

\* Optional Casters #CG-005-1 \$ 31.50

#### Two Panel Model

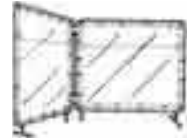

Item #	Height	Wings	Price
SC-010-253	5'	3'	\$ 244.75
SC-010-254	5'	4'	\$ 271.00
SC-010-255	5'	5'	\$ 296.95
SC-010-256	5'	6'	\$ 323.50
SC-010-257	5'	7'	\$ 342.55
SC-010-258	5'	8'	\$ 361.25
SC-010-263	6'	3'	\$ 267.10
SC-010-264	6'	4'	\$ 289.40
SC-010-265	6'	5'	\$ 323.50
SC-010-266	6'	6'	\$ 346.15
SC-010-268	6'	8'	\$ 387.50
SC-010-269	6'	9'	\$ 411.10
SC-010-2610	6'	10'	\$ 432.80

\* Optional Casters #CG-005-2 \$ 47.25

#### Three Panel Model



Item #	Height	Centre	Wings	Price
SC-010-3533	5'	3'	3'	\$ 353.35
SC-010-3543	5'	4'	3'	\$ 364.85
SC-010-3544	5'	4'	4'	\$ 376.35
SC-010-3555	5'	5'	5'	\$ 417.70
SC-010-3563	5'	6'	3'	\$ 376.35
SC-010-3564	5'	6'	4'	\$ 402.60
SC-010-3566	5'	6'	6'	\$ 440.00
SC-010-3588	5'	8'	8'	\$ 496.75
SC-010-3633	6'	3'	3'	\$ 368.45
SC-010-3644	6'	4'	4'	\$ 414.40
SC-010-3655	6'	5'	5'	\$ 440.00
SC-010-3666	6'	6'	6'	\$ 481.35
SC-010-3686	6'	8'	6'	\$ 511.55
SC-010-3688	6'	8'	8'	\$ 541.40

\* Optional Casters #CG-005-3 \$ 63.00

#### Four Panel Model

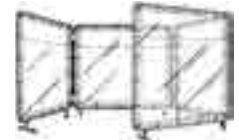

Item #	Height	Wings	Price
SC-010-453	5'	3'	\$ 474.10
SC-010-454	5'	4'	\$ 511.85
SC-010-455	5'	5'	\$ 553.20
SC-010-456	5'	6'	\$ 590.60
SC-010-457	5'	7'	\$ 621.10
SC-010-458	5'	8'	\$ 654.25
SC-010-459	5'	9'	\$ 687.40
SC-010-4510	5'	10'	\$ 718.90
SC-010-464	6'	4'	\$ 542.70
SC-010-465	6'	5'	\$ 590.60
SC-010-466	6'	6'	\$ 654.25
SC-010-468	6'	8'	\$ 748.45
SC-010-469	6'	9'	\$ 788.80
SC-010-4610	6'	10'	\$ 826.85

\* Optional Casters #CG-005-4 \$ 78.75

# Portable Safety Screens

## 14oz Vinyl-Poly

See Fabric # 013

### One Panel Model



Item #	Height	Width	Price
SC-013-153	5'	3'	\$ 137.45
SC-013-154	5'	4'	\$ 152.25
SC-013-155	5'	5'	\$ 165.05
SC-013-156	5'	6'	\$ 184.05
SC-013-157	5'	7'	\$ 202.75
SC-013-158	5'	8'	\$ 218.20
SC-013-159	5'	9'	\$ 236.90
SC-013-1510	5'	10'	\$ 252.00
SC-013-166	6'	6'	\$ 202.75
SC-013-167	6'	7'	\$ 226.05
SC-013-168	6'	8'	\$ 244.75
SC-013-169	6'	9'	\$ 263.80
SC-013-1610	6'	10'	\$ 282.15

\* Optional Casters #CG-005-1 \$ 31.50

### Two Panel Model

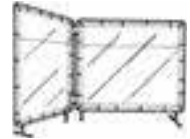

Item #	Height	Wings	Price
SC-013-253	5'	3'	\$ 244.75
SC-013-254	5'	4'	\$ 271.00
SC-013-255	5'	5'	\$ 296.95
SC-013-256	5'	6'	\$ 323.50
SC-013-257	5'	7'	\$ 342.55
SC-013-258	5'	8'	\$ 361.25
SC-013-263	6'	3'	\$ 267.10
SC-013-264	6'	4'	\$ 289.40
SC-013-265	6'	5'	\$ 323.50
SC-013-266	6'	6'	\$ 346.15
SC-013-268	6'	8'	\$ 387.50
SC-013-269	6'	9'	\$ 411.10
SC-013-2610	6'	10'	\$ 432.80

\* Optional Casters #CG-005-2 \$ 47.25

### Three Panel Model

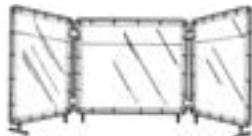

Item #	Height	Centre	Wings	Price
SC-013-3533	5'	3'	3'	\$ 353.35
SC-013-3543	5'	4'	3'	\$ 364.85
SC-013-3544	5'	4'	4'	\$ 376.35
SC-013-3555	5'	5'	5'	\$ 417.70
SC-013-3563	5'	6'	3'	\$ 376.35
SC-013-3564	5'	6'	4'	\$ 402.60
SC-013-3566	5'	6'	6'	\$ 440.00
SC-013-3588	5'	8'	8'	\$ 496.75
SC-013-3633	6'	3'	3'	\$ 368.45
SC-013-3644	6'	4'	4'	\$ 414.40
SC-013-3655	6'	5'	5'	\$ 440.00
SC-013-3666	6'	6'	6'	\$ 481.35
SC-013-3686	6'	8'	6'	\$ 511.55
SC-013-3688	6'	8'	8'	\$ 541.40

\* Optional Casters #CG-005-3 \$ 63.00

### Four Panel Model

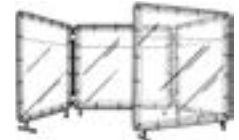

Item #	Height	Wings	Price
SC-013-453	5'	3'	\$ 474.10
SC-013-454	5'	4'	\$ 511.85
SC-013-455	5'	5'	\$ 553.20
SC-013-456	5'	6'	\$ 590.60
SC-013-457	5'	7'	\$ 621.10
SC-013-458	5'	8'	\$ 654.25
SC-013-459	5'	9'	\$ 687.40
SC-013-4510	5'	10'	\$ 718.90
SC-013-464	6'	4'	\$ 542.70
SC-013-465	6'	5'	\$ 590.60
SC-013-466	6'	6'	\$ 654.25
SC-013-468	6'	8'	\$ 748.45
SC-013-469	6'	9'	\$ 788.80
SC-013-4610	6'	10'	\$ 826.85

\* Optional Casters #CG-005-4 \$ 78.75





**INDUSTRIES INC.**

PO Box 7132  
London, Ontario  
N5Y 4J9

Tel: (519) 452-3780  
Fax: (519) 452-3053

2025

- 14 -

# Curtain, Screen and Strip Accessories

Item #	Description	Price
CG-001	Curtain Hook (1" to 2" pipe), see sample # 052	\$ 0.50 each
CG-002	Frame Hook (to 7/8" pipe), see sample # 051	\$ 0.35 each
CG-003	'S' Hook (fits 1/4" DIA wire)	\$ 0.45 each
CG-004	'See Thru' Vinyl Patch Kit (12" x 24"), specify colour	\$23.60 each
CG-006-1	Top Frame Elbow	\$13.10 each
CG-006-2	Base Elbow with Straight Stub	\$16.40 each
CG-006-3	Base Elbow with Tee Leg	\$26.25 each
CG-007	Hinge Set for Multi Panel Frames (2 per set)	\$21.00 / set
CG-011-5	5' Corner Curtain, specify fabric	\$10.50 each
CG-011-6	6' Corner Curtain, specify fabric	\$13.10 each
CG-014-1	1" Hook and Loop Fastener (2 sides installed on curtains)	\$ 2.60 / foot
CG-015	Steel Chain Weight installed in Curtain Hem	\$ 3.90 / foot
CG-016	Galvanized Chain Weight installed in Curtain Hem	\$ 4.60 / foot
CG-017	Angle Iron - Galvanized prepunched complete with nuts, bolts, washers	\$ 9.45 / foot
CG-018	3/4" Galvanized Schedule 40 Pipe	\$ 5.25 / foot



**INDUSTRIES INC.**

PO Box 7132  
London, Ontario  
N5Y 4J9

Tel: (519) 452-3780  
Fax: (519) 452-3053

# Safety Curtains

## Yellow 'See Thru' Vinyl

See Fabric # 001

### Description

14 mil PVC Vinyl sheeting, flame resistant, meeting requirements of CPAI-84, and California Fire Marshall's Registration # F191. These transparent Vinyl Safety Curtains exceed OSHA specifications for screening Stick, Mig and Tig Welding operations. This material has been specifically formulated to absorb dangerous ultraviolet radiation to prevent personnel from eye flash burns.

### Sizes

Curtains are fabricated to any size with electronically sealed seams and hems on all four sides. Vinyl grommets can be installed on the top side on 12" centers or on all four sides on 12" centers.

### Ordering Information

Curtains can be ordered to any size. Specify fabric #, height x width and grommet location when ordering. Standard sizes are listed below with their respective item numbers.

### Pricing

Custom curtains with grommets on top only ..... \$ 1.85 per square foot  
Custom curtains with grommets on four sides ..... \$ 2.00 per square foot  
*Minimum curtain charge ..... \$20.00 per curtain*

#### Standard Sizes Grommets Top Only

Item #	Height	Width	Price
FC-001-0503-T	5'	3'	\$ 27.75
FC-001-0504-T	5'	4'	\$ 37.00
FC-001-0505-T	5'	5'	\$ 46.25
FC-001-0506-T	5'	6'	\$ 55.50
FC-001-0507-T	5'	7'	\$ 64.75
FC-001-0508-T	5'	8'	\$ 74.00
FC-001-0509-T	5'	9'	\$ 83.25
FC-001-0510-T	5'	10'	\$ 92.50
FC-001-0511-T	5'	11'	\$101.75
FC-001-0512-T	5'	12'	\$111.00
FC-001-0603-T	6'	3'	\$ 33.30
FC-001-0604-T	6'	4'	\$ 44.40
FC-001-0605-T	6'	5'	\$ 55.50
FC-001-0606-T	6'	6'	\$ 66.60
FC-001-0607-T	6'	7'	\$ 77.70
FC-001-0608-T	6'	8'	\$ 88.80
FC-001-0609-T	6'	9'	\$ 99.90
FC-001-0610-T	6'	10'	\$111.00
FC-001-0611-T	6'	11'	\$122.10
FC-001-0612-T	6'	12'	\$133.20

#### Standard Sizes Grommets 4 sides

Item #	Height	Width	Price
FC-001-0503-F	5'	3'	\$ 30.00
FC-001-0504-F	5'	4'	\$ 40.00
FC-001-0505-F	5'	5'	\$ 50.00
FC-001-0506-F	5'	6'	\$ 60.00
FC-001-0507-F	5'	7'	\$ 70.00
FC-001-0508-F	5'	8'	\$ 80.00
FC-001-0509-F	5'	9'	\$ 90.00
FC-001-0510-F	5'	10'	\$100.00
FC-001-0511-F	5'	11'	\$110.00
FC-001-0512-F	5'	12'	\$120.00
FC-001-0603-F	6'	3'	\$ 36.00
FC-001-0604-F	6'	4'	\$ 48.00
FC-001-0605-F	6'	5'	\$ 60.00
FC-001-0606-F	6'	6'	\$ 72.00
FC-001-0607-F	6'	7'	\$ 84.00
FC-001-0608-F	6'	8'	\$ 96.00
FC-001-0609-F	6'	9'	\$108.00
FC-001-0610-F	6'	10'	\$120.00
FC-001-0611-F	6'	11'	\$132.00
FC-001-0612-F	6'	12'	\$144.00



**INDUSTRIES INC.**

PO Box 7132  
London, Ontario  
N5Y 4J9

Tel: (519) 452-3780  
Fax: (519) 452-3053

# Safety Curtains

## Orange 'See Thru' Vinyl

See Fabric # 002

### Description

14 mil PVC Vinyl sheeting, flame resistant, meeting requirements of CPAI-84, and California Fire Marshall's Registration # F191. These transparent Vinyl Safety Curtains exceed OSHA specifications for screening Stick, Mig and Tig Welding operations. This material has been specifically formulated to absorb dangerous ultraviolet radiation to prevent personnel from eye flash burns.

### Sizes

Curtains are fabricated to any size with electronically sealed seams and hems on all four sides. Vinyl grommets can be installed on the top side on 12" centers or on all four sides on 12" centers.

### Ordering Information

Curtains can be ordered to any size. Specify fabric #, height x width and grommet location when ordering. Standard sizes are listed below with their respective item numbers.

### Pricing

Custom curtains with grommets on top only ..... \$ 1.85 per square foot  
Custom curtains with grommets on four sides ..... \$ 2.00 per square foot  
*Minimum curtain charge ..... \$20.00 per curtain*

#### Standard Sizes Grommets Top Only

Item #	Height	Width	Price
FC-002-0503-T	5'	3'	\$ 27.75
FC-002-0504-T	5'	4'	\$ 37.00
FC-002-0505-T	5'	5'	\$ 46.25
FC-002-0506-T	5'	6'	\$ 55.50
FC-002-0507-T	5'	7'	\$ 64.75
FC-002-0508-T	5'	8'	\$ 74.00
FC-002-0509-T	5'	9'	\$ 83.25
FC-002-0510-T	5'	10'	\$ 92.50
FC-002-0511-T	5'	11'	\$101.75
FC-002-0512-T	5'	12'	\$111.00
FC-002-0603-T	6'	3'	\$ 33.30
FC-002-0604-T	6'	4'	\$ 44.40
FC-002-0605-T	6'	5'	\$ 55.50
FC-002-0606-T	6'	6'	\$ 66.60
FC-002-0607-T	6'	7'	\$ 77.70
FC-002-0608-T	6'	8'	\$ 88.80
FC-002-0609-T	6'	9'	\$ 99.90
FC-002-0610-T	6'	10'	\$111.00
FC-002-0611-T	6'	11'	\$122.10
FC-002-0612-T	6'	12'	\$133.20

#### Standard Sizes Grommets 4 sides

Item #	Height	Width	Price
FC-002-0503-F	5'	3'	\$ 30.00
FC-002-0504-F	5'	4'	\$ 40.00
FC-002-0505-F	5'	5'	\$ 50.00
FC-002-0506-F	5'	6'	\$ 60.00
FC-002-0507-F	5'	7'	\$ 70.00
FC-002-0508-F	5'	8'	\$ 80.00
FC-002-0509-F	5'	9'	\$ 90.00
FC-002-0510-F	5'	10'	\$100.00
FC-002-0511-F	5'	11'	\$110.00
FC-002-0512-F	5'	12'	\$120.00
FC-002-0603-F	6'	3'	\$ 36.00
FC-002-0604-F	6'	4'	\$ 48.00
FC-002-0605-F	6'	5'	\$ 60.00
FC-002-0606-F	6'	6'	\$ 72.00
FC-002-0607-F	6'	7'	\$ 84.00
FC-002-0608-F	6'	8'	\$ 96.00
FC-002-0609-F	6'	9'	\$108.00
FC-002-0610-F	6'	10'	\$120.00
FC-002-0611-F	6'	11'	\$132.00
FC-002-0612-F	6'	12'	\$144.00



**INDUSTRIES INC.**

PO Box 7132  
London, Ontario  
N5Y 4J9

Tel: (519) 452-3780  
Fax: (519) 452-3053

# Safety Curtains

## Blue 'See Thru' Vinyl

See Fabric # 003

### Description

14 mil PVC Vinyl sheeting, flame resistant, meeting requirements of CPAI-84, and California Fire Marshall's Registration # F191. These transparent Vinyl Safety Curtains exceed OSHA specifications for screening Stick, Mig and Tig Welding operations. This material has been specifically formulated to absorb dangerous ultraviolet radiation to prevent personnel from eye flash burns.

### Sizes

Curtains are fabricated to any size with electronically sealed seams and hems on all four sides. Vinyl grommets can be installed on the top side on 12" centers or on all four sides on 12" centers.

### Ordering Information

Curtains can be ordered to any size. Specify fabric #, height x width and grommet location when ordering. Standard sizes are listed below with their respective item numbers.

### Pricing

Custom curtains with grommets on top only ..... \$ 1.85 per square foot  
Custom curtains with grommets on four sides ..... \$ 2.00 per square foot  
*Minimum curtain charge ..... \$20.00 per curtain*

#### Standard Sizes Grommets Top Only

Item #	Height	Width	Price
FC-003-0503-T	5'	3'	\$ 27.75
FC-003-0504-T	5'	4'	\$ 37.00
FC-003-0505-T	5'	5'	\$ 46.25
FC-003-0506-T	5'	6'	\$ 55.50
FC-003-0507-T	5'	7'	\$ 64.75
FC-003-0508-T	5'	8'	\$ 74.00
FC-003-0509-T	5'	9'	\$ 83.25
FC-003-0510-T	5'	10'	\$ 92.50
FC-003-0511-T	5'	11'	\$101.75
FC-003-0512-T	5'	12'	\$111.00
FC-003-0603-T	6'	3'	\$ 33.30
FC-003-0604-T	6'	4'	\$ 44.40
FC-003-0605-T	6'	5'	\$ 55.50
FC-003-0606-T	6'	6'	\$ 66.60
FC-003-0607-T	6'	7'	\$ 77.70
FC-003-0608-T	6'	8'	\$ 88.80
FC-003-0609-T	6'	9'	\$ 99.90
FC-003-0610-T	6'	10'	\$111.00
FC-003-0611-T	6'	11'	\$122.10
FC-003-0612-T	6'	12'	\$133.20

#### Standard Sizes Grommets 4 sides

Item #	Height	Width	Price
FC-003-0503-F	5'	3'	\$ 30.00
FC-003-0504-F	5'	4'	\$ 40.00
FC-003-0505-F	5'	5'	\$ 50.00
FC-003-0506-F	5'	6'	\$ 60.00
FC-003-0507-F	5'	7'	\$ 70.00
FC-003-0508-F	5'	8'	\$ 80.00
FC-003-0509-F	5'	9'	\$ 90.00
FC-003-0510-F	5'	10'	\$100.00
FC-003-0511-F	5'	11'	\$110.00
FC-003-0512-F	5'	12'	\$120.00
FC-003-0603-F	6'	3'	\$ 36.00
FC-003-0604-F	6'	4'	\$ 48.00
FC-003-0605-F	6'	5'	\$ 60.00
FC-003-0606-F	6'	6'	\$ 72.00
FC-003-0607-F	6'	7'	\$ 84.00
FC-003-0608-F	6'	8'	\$ 96.00
FC-003-0609-F	6'	9'	\$108.00
FC-003-0610-F	6'	10'	\$120.00
FC-003-0611-F	6'	11'	\$132.00
FC-003-0612-F	6'	12'	\$144.00



**INDUSTRIES INC.**

PO Box 7132  
London, Ontario  
N5Y 4J9

Tel: (519) 452-3780  
Fax: (519) 452-3053

# Safety Curtains

## Green 'See Thru' Vinyl

See Fabric # 004

### Description

14 mil PVC Vinyl sheeting, flame resistant, meeting requirements of CPAI-84, and California Fire Marshall's Registration # F191. These transparent Vinyl Safety Curtains exceed OSHA specifications for screening Stick, Mig and Tig Welding operations. This material has been specifically formulated to absorb dangerous ultraviolet radiation to prevent personnel from eye flash burns.

### Sizes

Curtains are fabricated to any size with electronically sealed seams and hems on all four sides. Vinyl grommets can be installed on the top side on 12" centers or on all four sides on 12" centers.

### Ordering Information

Curtains can be ordered to any size. Specify fabric #, height x width and grommet location when ordering. Standard sizes are listed below with their respective item numbers.

### Pricing

Custom curtains with grommets on top only ..... \$ 1.85 per square foot  
Custom curtains with grommets on four sides ..... \$ 2.00 per square foot  
*Minimum curtain charge ..... \$20.00 per curtain*

#### Standard Sizes Grommets Top Only

Item #	Height	Width	Price
FC-004-0503-T	5'	3'	\$ 27.75
FC-004-0504-T	5'	4'	\$ 37.00
FC-004-0505-T	5'	5'	\$ 46.25
FC-004-0506-T	5'	6'	\$ 55.50
FC-004-0507-T	5'	7'	\$ 64.75
FC-004-0508-T	5'	8'	\$ 74.00
FC-004-0509-T	5'	9'	\$ 83.25
FC-004-0510-T	5'	10'	\$ 92.50
FC-004-0511-T	5'	11'	\$101.75
FC-004-0512-T	5'	12'	\$111.00
FC-004-0603-T	6'	3'	\$ 33.30
FC-004-0604-T	6'	4'	\$ 44.40
FC-004-0605-T	6'	5'	\$ 55.50
FC-004-0606-T	6'	6'	\$ 66.60
FC-004-0607-T	6'	7'	\$ 77.70
FC-004-0608-T	6'	8'	\$ 88.80
FC-004-0609-T	6'	9'	\$ 99.90
FC-004-0610-T	6'	10'	\$111.00
FC-004-0611-T	6'	11'	\$122.10
FC-004-0612-T	6'	12'	\$133.20

#### Standard Sizes Grommets 4 sides

Item #	Height	Width	Price
FC-004-0503-F	5'	3'	\$ 30.00
FC-004-0504-F	5'	4'	\$ 40.00
FC-004-0505-F	5'	5'	\$ 50.00
FC-004-0506-F	5'	6'	\$ 60.00
FC-004-0507-F	5'	7'	\$ 70.00
FC-004-0508-F	5'	8'	\$ 80.00
FC-004-0509-F	5'	9'	\$ 90.00
FC-004-0510-F	5'	10'	\$100.00
FC-004-0511-F	5'	11'	\$110.00
FC-004-0512-F	5'	12'	\$120.00
FC-004-0603-F	6'	3'	\$ 36.00
FC-004-0604-F	6'	4'	\$ 48.00
FC-004-0605-F	6'	5'	\$ 60.00
FC-004-0606-F	6'	6'	\$ 72.00
FC-004-0607-F	6'	7'	\$ 84.00
FC-004-0608-F	6'	8'	\$ 96.00
FC-004-0609-F	6'	9'	\$108.00
FC-004-0610-F	6'	10'	\$120.00
FC-004-0611-F	6'	11'	\$132.00
FC-004-0612-F	6'	12'	\$144.00



**INDUSTRIES INC.**

PO Box 7132  
London, Ontario  
N5Y 4J9

Tel: (519) 452-3780  
Fax: (519) 452-3053

# Safety Curtains

## Shade 8 'See Thru' Vinyl

See Fabric # 005

### Description

14 mil PVC Vinyl sheeting, flame resistant, meeting requirements of CPAI-84, and California Fire Marshall's Registration # F191. These transparent Vinyl Safety Curtains exceed OSHA specifications for screening Stick, Mig and Tig Welding operations. This material has been specifically formulated to absorb dangerous ultraviolet radiation to prevent personnel from eye flash burns.

### Sizes

Curtains are fabricated to any size with electronically sealed seams and hems on all four sides. Vinyl grommets can be installed on the top side on 12" centers or on all four sides on 12" centers.

### Ordering Information

Curtains can be ordered to any size. Specify fabric #, height x width and grommet location when ordering. Standard sizes are listed below with their respective item numbers.

### Pricing

Custom curtains with grommets on top only ..... \$ 1.85 per square foot  
Custom curtains with grommets on four sides ..... \$ 2.00 per square foot  
*Minimum curtain charge ..... \$20.00 per curtain*

#### Standard Sizes Grommets Top Only

Item #	Height	Width	Price
FC-005-0503-T	5'	3'	\$ 27.75
FC-005-0504-T	5'	4'	\$ 37.00
FC-005-0505-T	5'	5'	\$ 46.25
FC-005-0506-T	5'	6'	\$ 55.50
FC-005-0507-T	5'	7'	\$ 64.75
FC-005-0508-T	5'	8'	\$ 74.00
FC-005-0509-T	5'	9'	\$ 83.25
FC-005-0510-T	5'	10'	\$ 92.50
FC-005-0511-T	5'	11'	\$101.75
FC-005-0512-T	5'	12'	\$111.00
FC-005-0603-T	6'	3'	\$ 33.30
FC-005-0604-T	6'	4'	\$ 44.40
FC-005-0605-T	6'	5'	\$ 55.50
FC-005-0606-T	6'	6'	\$ 66.60
FC-005-0607-T	6'	7'	\$ 77.70
FC-005-0608-T	6'	8'	\$ 88.80
FC-005-0609-T	6'	9'	\$ 99.90
FC-005-0610-T	6'	10'	\$111.00
FC-005-0611-T	6'	11'	\$122.10
FC-005-0612-T	6'	12'	\$133.20

#### Standard Sizes Grommets 4 sides

Item #	Height	Width	Price
FC-005-0503-F	5'	3'	\$ 30.00
FC-005-0504-F	5'	4'	\$ 40.00
FC-005-0505-F	5'	5'	\$ 50.00
FC-005-0506-F	5'	6'	\$ 60.00
FC-005-0507-F	5'	7'	\$ 70.00
FC-005-0508-F	5'	8'	\$ 80.00
FC-005-0509-F	5'	9'	\$ 90.00
FC-005-0510-F	5'	10'	\$100.00
FC-005-0511-F	5'	11'	\$110.00
FC-005-0512-F	5'	12'	\$120.00
FC-005-0603-F	6'	3'	\$ 36.00
FC-005-0604-F	6'	4'	\$ 48.00
FC-005-0605-F	6'	5'	\$ 60.00
FC-005-0606-F	6'	6'	\$ 72.00
FC-005-0607-F	6'	7'	\$ 84.00
FC-005-0608-F	6'	8'	\$ 96.00
FC-005-0609-F	6'	9'	\$108.00
FC-005-0610-F	6'	10'	\$120.00
FC-005-0611-F	6'	11'	\$132.00
FC-005-0612-F	6'	12'	\$144.00





**INDUSTRIES INC.**

PO Box 7132  
London, Ontario  
N5Y 4J9

Tel: (519) 452-3780  
Fax: (519) 452-3053

# Safety Curtains

## Combo 'See Thru' Vinyl

See Fabric # 006

### Description

14 mil PVC Vinyl sheeting, flame resistant, meeting requirements of CPAI-84, and California Fire Marshall's Registration # F191. These transparent Vinyl Safety Curtains exceed OSHA specifications for screening Stick, Mig and Tig Welding operations. This material has been specifically formulated to absorb dangerous ultraviolet radiation to prevent personnel from eye flash burns.

### Sizes

Curtains are fabricated to any size with electronically sealed seams and hems on all four sides. Vinyl grommets can be installed on the top side on 12" centers or on all four sides on 12" centers.

### Ordering Information

Curtains can be ordered to any size. Specify fabric #, height x width and grommet location when ordering. Standard sizes are listed below with their respective item numbers.

### Pricing

Custom curtains with grommets on top only ..... \$ 1.85 per square foot  
Custom curtains with grommets on four sides ..... \$ 2.00 per square foot  
*Minimum curtain charge ..... \$20.00 per curtain*

#### Standard Sizes Grommets Top Only

Item #	Height	Width	Price
FC-006-0503-T	5'	3'	\$ 27.75
FC-006-0504-T	5'	4'	\$ 37.00
FC-006-0505-T	5'	5'	\$ 46.25
FC-006-0506-T	5'	6'	\$ 55.50
FC-006-0507-T	5'	7'	\$ 64.75
FC-006-0508-T	5'	8'	\$ 74.00
FC-006-0509-T	5'	9'	\$ 83.25
FC-006-0510-T	5'	10'	\$ 92.50
FC-006-0511-T	5'	11'	\$101.75
FC-006-0512-T	5'	12'	\$111.00
FC-006-0603-T	6'	3'	\$ 33.30
FC-006-0604-T	6'	4'	\$ 44.40
FC-006-0605-T	6'	5'	\$ 55.50
FC-006-0606-T	6'	6'	\$ 66.60
FC-006-0607-T	6'	7'	\$ 77.70
FC-006-0608-T	6'	8'	\$ 88.80
FC-006-0609-T	6'	9'	\$ 99.90
FC-006-0610-T	6'	10'	\$111.00
FC-006-0611-T	6'	11'	\$122.10
FC-006-0612-T	6'	12'	\$133.20

#### Standard Sizes Grommets 4 sides

Item #	Height	Width	Price
FC-006-0503-F	5'	3'	\$ 30.00
FC-006-0504-F	5'	4'	\$ 40.00
FC-006-0505-F	5'	5'	\$ 50.00
FC-006-0506-F	5'	6'	\$ 60.00
FC-006-0507-F	5'	7'	\$ 70.00
FC-006-0508-F	5'	8'	\$ 80.00
FC-006-0509-F	5'	9'	\$ 90.00
FC-006-0510-F	5'	10'	\$100.00
FC-006-0511-F	5'	11'	\$110.00
FC-006-0512-F	5'	12'	\$120.00
FC-006-0603-F	6'	3'	\$ 36.00
FC-006-0604-F	6'	4'	\$ 48.00
FC-006-0605-F	6'	5'	\$ 60.00
FC-006-0606-F	6'	6'	\$ 72.00
FC-006-0607-F	6'	7'	\$ 84.00
FC-006-0608-F	6'	8'	\$ 96.00
FC-006-0609-F	6'	9'	\$108.00
FC-006-0610-F	6'	10'	\$120.00
FC-006-0611-F	6'	11'	\$132.00
FC-006-0612-F	6'	12'	\$144.00



**INDUSTRIES INC.**

PO Box 7132  
London, Ontario  
N5Y 4J9

Tel: (519) 452-3780  
Fax: (519) 452-3053

# Safety Curtains

## 16 mil Clear 'See Thru' Vinyl

See Fabric # 007

### Description

14 mil PVC Vinyl sheeting, flame resistant, meeting requirements of CPAI-84, and California Fire Marshall's Registration # F191. These transparent Vinyl Safety Curtains exceed OSHA specifications for screening Stick, Mig and Tig Welding operations. This material has been specifically formulated to absorb dangerous ultraviolet radiation to prevent personnel from eye flash burns.

### Sizes

Curtains are fabricated to any size with electronically sealed seams and hems on all four sides. Vinyl grommets can be installed on the top side on 12" centers or on all four sides on 12" centers.

### Ordering Information

Curtains can be ordered to any size. Specify fabric #, height x width and grommet location when ordering. Standard sizes are listed below with their respective item numbers.

### Pricing

Custom curtains with grommets on top only ..... \$ 1.85 per square foot  
Custom curtains with grommets on four sides ..... \$ 2.00 per square foot  
*Minimum curtain charge ..... \$20.00 per curtain*

#### Standard Sizes Grommets Top Only

Item #	Height	Width	Price
FC-007-0503-T	5'	3'	\$ 27.75
FC-007-0504-T	5'	4'	\$ 37.00
FC-007-0505-T	5'	5'	\$ 46.25
FC-007-0506-T	5'	6'	\$ 55.50
FC-007-0507-T	5'	7'	\$ 64.75
FC-007-0508-T	5'	8'	\$ 74.00
FC-007-0509-T	5'	9'	\$ 83.25
FC-007-0510-T	5'	10'	\$ 92.50
FC-007-0511-T	5'	11'	\$101.75
FC-007-0512-T	5'	12'	\$111.00
FC-007-0603-T	6'	3'	\$ 33.30
FC-007-0604-T	6'	4'	\$ 44.40
FC-007-0605-T	6'	5'	\$ 55.50
FC-007-0606-T	6'	6'	\$ 66.60
FC-007-0607-T	6'	7'	\$ 77.70
FC-007-0608-T	6'	8'	\$ 88.80
FC-007-0609-T	6'	9'	\$ 99.90
FC-007-0610-T	6'	10'	\$111.00
FC-007-0611-T	6'	11'	\$122.10
FC-007-0612-T	6'	12'	\$133.20

#### Standard Sizes Grommets 4 sides

Item #	Height	Width	Price
FC-007-0503-F	5'	3'	\$ 30.00
FC-007-0504-F	5'	4'	\$ 40.00
FC-007-0505-F	5'	5'	\$ 50.00
FC-007-0506-F	5'	6'	\$ 60.00
FC-007-0507-F	5'	7'	\$ 70.00
FC-007-0508-F	5'	8'	\$ 80.00
FC-007-0509-F	5'	9'	\$ 90.00
FC-007-0510-F	5'	10'	\$100.00
FC-007-0511-F	5'	11'	\$110.00
FC-007-0512-F	5'	12'	\$120.00
FC-007-0603-F	6'	3'	\$ 36.00
FC-007-0604-F	6'	4'	\$ 48.00
FC-007-0605-F	6'	5'	\$ 60.00
FC-007-0606-F	6'	6'	\$ 72.00
FC-007-0607-F	6'	7'	\$ 84.00
FC-007-0608-F	6'	8'	\$ 96.00
FC-007-0609-F	6'	9'	\$108.00
FC-007-0610-F	6'	10'	\$120.00
FC-007-0611-F	6'	11'	\$132.00
FC-007-0612-F	6'	12'	\$144.00



**INDUSTRIES INC.**

PO Box 7132  
London, Ontario  
N5Y 4J9

Tel: (519) 452-3780  
Fax: (519) 452-3053

# Safety Curtains

## 20 mil Clear 'See Thru' Vinyl

See Fabric # 008

### Description

'See Thru' feature with 100% light transmission, ideal for protection around plant machinery where hidden objects could be a hazard, as wind breaks, dividers and general shop curtains. Resistant to flame, water, grease, oil and most acids. Flame resistant. Not to be used as welding curtains.

### Sizes

Curtains are fabricated to any size with electronically sealed seams and hems on all four sides. Vinyl grommets can be installed on the top side on 12" centers or on all four sides on 12" centers.

### Ordering Information

Curtains can be ordered to any size. Specify fabric #, height x width and grommet location when ordering. Standard sizes are listed below with their respective item numbers.

### Pricing

Custom curtains with grommets on top only ..... \$ 2.35 per square foot  
Custom curtains with grommets on four sides ..... \$ 2.50 per square foot  
*Minimum curtain charge ..... \$20.00 per curtain*

### Standard Sizes Grommets Top Only

Item #	Height	Width	Price
FC-008-0503-T	5'	3'	\$ 35.25
FC-008-0504-T	5'	4'	\$ 47.00
FC-008-0505-T	5'	5'	\$ 58.75
FC-008-0506-T	5'	6'	\$ 70.50
FC-008-0507-T	5'	7'	\$ 82.25
FC-008-0508-T	5'	8'	\$ 94.00
FC-008-0509-T	5'	9'	\$ 105.75
FC-008-0510-T	5'	10'	\$ 117.50
FC-008-0511-T	5'	11'	\$ 129.25
FC-008-0512-T	5'	12'	\$ 141.00
FC-008-0603-T	6'	3'	\$ 42.30
FC-008-0604-T	6'	4'	\$ 56.40
FC-008-0605-T	6'	5'	\$ 70.50
FC-008-0606-T	6'	6'	\$ 84.60
FC-008-0607-T	6'	7'	\$ 98.70
FC-008-0608-T	6'	8'	\$ 112.80
FC-008-0609-T	6'	9'	\$ 126.90
FC-008-0610-T	6'	10'	\$ 141.00
FC-008-0611-T	6'	11'	\$ 155.10
FC-008-0612-T	6'	12'	\$ 169.20

### Standard Sizes Grommets 4 sides

Item #	Height	Width	Price
FC-008-0503-F	5'	3'	\$ 37.50
FC-008-0504-F	5'	4'	\$ 50.00
FC-008-0505-F	5'	5'	\$ 62.50
FC-008-0506-F	5'	6'	\$ 75.00
FC-008-0507-F	5'	7'	\$ 87.50
FC-008-0508-F	5'	8'	\$ 100.00
FC-008-0509-F	5'	9'	\$ 112.50
FC-008-0510-F	5'	10'	\$ 125.00
FC-008-0511-F	5'	11'	\$ 137.50
FC-008-0512-F	5'	12'	\$ 150.00
FC-008-0603-F	6'	3'	\$ 45.00
FC-008-0604-F	6'	4'	\$ 60.00
FC-008-0605-F	6'	5'	\$ 75.00
FC-008-0606-F	6'	6'	\$ 90.00
FC-008-0607-F	6'	7'	\$ 105.00
FC-008-0608-F	6'	8'	\$ 120.00
FC-008-0609-F	6'	9'	\$ 135.00
FC-008-0610-F	6'	10'	\$ 150.00
FC-008-0611-F	6'	11'	\$ 165.00
FC-008-0612-F	6'	12'	\$ 180.00



**INDUSTRIES INC.**

PO Box 7132  
London, Ontario  
N5Y 4J9

Tel: (519) 452-3780  
Fax: (519) 452-3053

# Safety Curtains

## 40 mil Clear 'See Thru' Vinyl

See Fabric # 009-CLR

### Description

'See Thru' feature with 100% light transmission, ideal for protection around plant machinery where hidden objects could be a hazard, as wind breaks, dividers and general shop curtains. Resistant to flame, water, grease, oil and most acids. Flame resistant. Not to be used as welding curtains.

### Sizes

Curtains are fabricated to any size with electronically sealed seams and hems. Brass grommets can be installed on the top side on 12" centers or on all four sides on 12" centers.

### Ordering Information

Curtains can be ordered to any size. Specify fabric #, height x width and grommet location when ordering. Standard sizes are listed below with their respective item numbers.

### Pricing

Custom curtains with grommets on top only ..... \$ 4.25 per square foot  
Custom curtains with grommets on four sides ..... \$ 4.40 per square foot  
*Minimum curtain charge ..... \$20.00 per curtain*

#### Standard Sizes Grommets Top Only

Item #	Height	Width	Price
FC-009-CLR-0403-T	4'	3'	\$ 51.00
FC-009-CLR-0404-T	4'	4'	\$ 68.00
FC-009-CLR-0405-T	4'	5'	\$ 85.00
FC-009-CLR-0406-T	4'	6'	\$ 102.00
FC-009-CLR-0407-T	4'	7'	\$ 119.00
FC-009-CLR-0408-T	4'	8'	\$ 136.00
FC-009-CLR-0409-T	4'	9'	\$ 153.00
FC-009-CLR-0410-T	4'	10'	\$ 170.00
FC-009-CLR-0411-T	4'	11'	\$ 187.00
FC-009-CLR-0412-T	4'	12'	\$ 204.00

#### Standard Sizes Grommets 4 sides

Item #	Height	Width	Price
FC-009-CLR-0403-F	4'	3'	\$ 52.80
FC-009-CLR-0404-F	4'	4'	\$ 70.40
FC-009-CLR-0405-F	4'	5'	\$ 88.00
FC-009-CLR-0406-F	4'	6'	\$ 105.60
FC-009-CLR-0407-F	4'	7'	\$ 123.20
FC-009-CLR-0408-F	4'	8'	\$ 140.80
FC-009-CLR-0409-F	4'	9'	\$ 158.40
FC-009-CLR-0410-F	4'	10'	\$ 176.00
FC-009-CLR-0411-F	4'	11'	\$ 193.60
FC-009-CLR-0412-F	4'	12'	\$ 211.20



**INDUSTRIES INC.**

PO Box 7132  
London, Ontario  
N5Y 4J9

Tel: (519) 452-3780  
Fax: (519) 452-3053

# Safety Curtains

## 40 mil Orange 'See Thru' Vinyl

See Fabric # 009-ORN

### Description

'See Thru' feature with 100% light transmission, ideal for protection around plant machinery where hidden objects could be a hazard, as wind breaks, dividers and general shop curtains. Resistant to flame, water, grease, oil and most acids. Flame resistant. Not to be used as welding curtains.

### Sizes

Curtains are fabricated to any size with electronically sealed seams and hems. Brass grommets can be installed on the top side on 12" centers or on all four sides on 12" centers.

### Ordering Information

Curtains can be ordered to any size. Specify fabric #, height x width and grommet location when ordering. Standard sizes are listed below with their respective item numbers.

### Pricing

Custom curtains with grommets on top only ..... \$ 4.25 per square foot  
Custom curtains with grommets on four sides ..... \$ 4.40 per square foot  
*Minimum curtain charge ..... \$20.00 per curtain*

#### Standard Sizes Grommets Top Only

Item #	Height	Width	Price
FC-009-ORN-0403-T	4'	3'	\$ 51.00
FC-009-ORN-0404-T	4'	4'	\$ 68.00
FC-009-ORN-0405-T	4'	5'	\$ 85.00
FC-009-ORN-0406-T	4'	6'	\$ 102.00
FC-009-ORN-0407-T	4'	7'	\$ 119.00
FC-009-ORN-0408-T	4'	8'	\$ 136.00
FC-009-ORN-0409-T	4'	9'	\$ 153.00
FC-009-ORN-0410-T	4'	10'	\$ 170.00
FC-009-ORN-0411-T	4'	11'	\$ 187.00
FC-009-ORN-0412-T	4'	12'	\$ 204.00

#### Standard Sizes Grommets 4 sides

Item #	Height	Width	Price
FC-009-ORN-0403-F	4'	3'	\$ 52.80
FC-009-ORN-0404-F	4'	4'	\$ 70.40
FC-009-ORN-0405-F	4'	5'	\$ 88.00
FC-009-ORN-0406-F	4'	6'	\$ 105.60
FC-009-ORN-0407-F	4'	7'	\$ 123.20
FC-009-ORN-0408-F	4'	8'	\$ 140.80
FC-009-ORN-0409-F	4'	9'	\$ 158.40
FC-009-ORN-0410-F	4'	10'	\$ 176.00
FC-009-ORN-0411-F	4'	11'	\$ 193.60
FC-009-ORN-0412-F	4'	12'	\$ 211.20



**INDUSTRIES INC.**

PO Box 7132  
London, Ontario  
N5Y 4J9

Tel: (519) 452-3780  
Fax: (519) 452-3053

# Safety Curtains

## 40 mil Gold 'See Thru' Vinyl

See Fabric # 009-GLD

### Description

'See Thru' feature with 100% light transmission, ideal for protection around plant machinery where hidden objects could be a hazard, as wind breaks, dividers and general shop curtains. Resistant to flame, water, grease, oil and most acids. Flame resistant. Not to be used as welding curtains.

### Sizes

Curtains are fabricated to any size with electronically sealed seams and hems. Brass grommets can be installed on the top side on 12" centers or on all four sides on 12" centers.

### Ordering Information

Curtains can be ordered to any size. Specify fabric #, height x width and grommet location when ordering. Standard sizes are listed below with their respective item numbers.

### Pricing

Custom curtains with grommets on top only ..... \$ 4.25 per square foot  
Custom curtains with grommets on four sides ..... \$ 4.40 per square foot  
*Minimum curtain charge ..... \$20.00 per curtain*

### Standard Sizes Grommets Top Only

Item #	Height	Width	Price
FC-009-GLD-0403-T	4'	3'	\$ 51.00
FC-009-GLD-0404-T	4'	4'	\$ 68.00
FC-009-GLD-0405-T	4'	5'	\$ 85.00
FC-009-GLD-0406-T	4'	6'	\$ 102.00
FC-009-GLD-0407-T	4'	7'	\$ 119.00
FC-009-GLD-0408-T	4'	8'	\$ 136.00
FC-009-GLD-0409-T	4'	9'	\$ 153.00
FC-009-GLD-0410-T	4'	10'	\$ 170.00
FC-009-GLD-0411-T	4'	11'	\$ 187.00
FC-009-GLD-0412-T	4'	12'	\$ 204.00

### Standard Sizes Grommets 4 sides

Item #	Height	Width	Price
FC-009-GLD-0403-F	4'	3'	\$ 52.80
FC-009-GLD-0404-F	4'	4'	\$ 70.40
FC-009-GLD-0405-F	4'	5'	\$ 88.00
FC-009-GLD-0406-F	4'	6'	\$ 105.60
FC-009-GLD-0407-F	4'	7'	\$ 123.20
FC-009-GLD-0408-F	4'	8'	\$ 140.80
FC-009-GLD-0409-F	4'	9'	\$ 158.40
FC-009-GLD-0410-F	4'	10'	\$ 176.00
FC-009-GLD-0411-F	4'	11'	\$ 193.60
FC-009-GLD-0412-F	4'	12'	\$ 211.20





**INDUSTRIES INC.**

PO Box 7132  
London, Ontario  
N5Y 4J9

Tel: (519) 452-3780  
Fax: (519) 452-3053

# Safety Curtains

## 10oz Flame Resistant Cotton Duck

See Fabric # 010

### Description

A high quality grade flame resistant cotton duck cloth for general plant usage. Resistant to flame, water, mold and mildew. Applications include, grinding and welding curtains and light duty spark blankets.

### Sizes

Curtains are fabricated to any size with stitched seams and hems. Brass grommets can be installed on the top side on 12" centers or on all four sides on 12" centers.

### Ordering Information

Curtains and Blankets can be ordered to any size. Specify fabric #, height x width and grommet location when ordering. Standard sizes are listed below with their respective item numbers.

### Pricing

Custom Curtains with grommets on top only ..... \$ 1.85 per square foot  
Custom Curtains with grommets on four sides ..... \$ 2.00 per square foot  
Custom Blankets - No Grommets ..... \$ 1.85 per square foot

#### Standard Sizes Grommets Top Only

Item #	Height	Width	Price
FC-010-0503-T	5'	3'	\$ 27.50
FC-010-0504-T	5'	4'	\$ 37.00
FC-010-0505-T	5'	5'	\$ 46.25
FC-010-0506-T	5'	6'	\$ 55.50
FC-010-0507-T	5'	7'	\$ 64.75
FC-010-0508-T	5'	8'	\$ 74.00
FC-010-0509-T	5'	9'	\$ 83.25
FC-010-0510-T	5'	10'	\$ 92.50
FC-010-0511-T	5'	11'	\$ 101.75
FC-010-0512-T	5'	12'	\$ 111.00
FC-010-0603-T	6'	3'	\$ 33.30
FC-010-0604-T	6'	4'	\$ 44.40
FC-010-0605-T	6'	5'	\$ 55.50
FC-010-0606-T	6'	6'	\$ 66.60
FC-010-0607-T	6'	7'	\$ 77.70
FC-010-0608-T	6'	8'	\$ 88.80
FC-010-0609-T	6'	9'	\$ 99.90
FC-010-0610-T	6'	10'	\$ 111.00
FC-010-0611-T	6'	11'	\$ 122.10
FC-010-0612-T	6'	12'	\$ 133.20

#### Standard Sizes Grommets 4 sides

Item #	Height	Width	Price
FC-010-0503-F	5'	3'	\$ 30.00
FC-010-0504-F	5'	4'	\$ 40.00
FC-010-0505-F	5'	5'	\$ 50.00
FC-010-0506-F	5'	6'	\$ 60.00
FC-010-0507-F	5'	7'	\$ 70.00
FC-010-0508-F	5'	8'	\$ 80.00
FC-010-0509-F	5'	9'	\$ 90.00
FC-010-0510-F	5'	10'	\$ 100.00
FC-010-0511-F	5'	11'	\$ 110.00
FC-010-0512-F	5'	12'	\$ 120.00
FC-010-0603-F	6'	3'	\$ 36.00
FC-010-0604-F	6'	4'	\$ 48.00
FC-010-0605-F	6'	5'	\$ 60.00
FC-010-0606-F	6'	6'	\$ 72.00
FC-010-0607-F	6'	7'	\$ 84.00
FC-010-0608-F	6'	8'	\$ 96.00
FC-010-0609-F	6'	9'	\$ 108.00
FC-010-0610-F	6'	10'	\$ 120.00
FC-010-0611-F	6'	11'	\$ 132.00
FC-010-0612-F	6'	12'	\$ 144.00

#### Blanket Sizes No Grommets

Item #	Height	Width	Price
FB-010-0503	5'	3'	\$ 27.75
FB-010-0504	5'	4'	\$ 37.00
FB-010-0505	5'	5'	\$ 46.25
FB-010-0506	5'	6'	\$ 55.50
FB-010-0507	5'	7'	\$ 64.75
FB-010-0508	5'	8'	\$ 74.00
FB-010-0509	5'	9'	\$ 83.25
FB-010-0510	5'	10'	\$ 92.50
FB-010-0511	5'	11'	\$ 101.75
FB-010-0512	5'	12'	\$ 111.00
FB-010-0515	5'	15'	\$ 138.75
FB-010-1005	10'	5'	\$ 92.50
FB-010-1006	10'	6'	\$ 111.00
FB-010-1007	10'	7'	\$ 129.50
FB-010-1008	10'	8'	\$ 148.00
FB-010-1010	10'	10'	\$ 185.00
FB-010-1012	10'	12'	\$ 222.00
FB-010-1015	10'	15'	\$ 277.50
FB-010-1020	10'	20'	\$ 370.00
FB-010-1520	15'	20'	\$ 555.00



**INDUSTRIES INC.**

PO Box 7132  
London, Ontario  
N5Y 4J9

Tel: (519) 452-3780  
Fax: (519) 452-3053

# Safety Curtains

## 15oz Flame Resistant Cotton Duck

See Fabric # 011

### Description

A high quality grade flame resistant cotton duck cloth for general plant usage. Resistant to flame, water, mold and mildew. Applications include, grinding and welding curtains and light duty spark blankets.

### Sizes

Curtains are fabricated to any size with stitched seams and hems. Brass grommets can be installed on the top side on 12" centers or on all four sides on 12" centers.

### Ordering Information

Curtains and blankets can be ordered to any size. Specify fabric #, height x width and grommet location when ordering. Standard sizes are listed below with their respective item numbers.

### Pricing

Custom curtains with grommets on top only ..... \$ 2.75 per square foot  
Custom curtains with grommets on four sides ..... \$ 2.90 per square foot  
Custom Blankets - No Grommets ..... \$ 2.75 per square foot

#### Standard Sizes Grommets Top Only

Item #	Height	Width	Price
FC-011-0503-T	5'	3'	\$ 41.25
FC-011-0504-T	5'	4'	\$ 55.00
FC-011-0505-T	5'	5'	\$ 68.75
FC-011-0506-T	5'	6'	\$ 82.50
FC-011-0507-T	5'	7'	\$ 96.25
FC-011-0508-T	5'	8'	\$ 110.00
FC-011-0509-T	5'	9'	\$ 123.75
FC-011-0510-T	5'	10'	\$ 137.50
FC-011-0511-T	5'	11'	\$ 151.25
FC-011-0512-T	5'	12'	\$ 165.00
FC-011-0603-T	6'	3'	\$ 49.50
FC-011-0604-T	6'	4'	\$ 66.00
FC-011-0605-T	6'	5'	\$ 82.50
FC-011-0606-T	6'	6'	\$ 99.00
FC-011-0607-T	6'	7'	\$ 115.50
FC-011-0608-T	6'	8'	\$ 132.00
FC-011-0609-T	6'	9'	\$ 148.50
FC-011-0610-T	6'	10'	\$ 165.00
FC-011-0611-T	6'	11'	\$ 181.50
FC-011-0612-T	6'	12'	\$ 198.00

#### Standard Sizes Grommets 4 sides

Item #	Height	Width	Price
FC-011-0503-F	5'	3'	\$ 43.50
FC-011-0504-F	5'	4'	\$ 58.00
FC-011-0505-F	5'	5'	\$ 72.50
FC-011-0506-F	5'	6'	\$ 87.00
FC-011-0507-F	5'	7'	\$ 101.50
FC-011-0508-F	5'	8'	\$ 116.00
FC-011-0509-F	5'	9'	\$ 130.50
FC-011-0510-F	5'	10'	\$ 145.00
FC-011-0511-F	5'	11'	\$ 159.50
FC-011-0512-F	5'	12'	\$ 174.00
FC-011-0603-F	6'	3'	\$ 52.20
FC-011-0604-F	6'	4'	\$ 69.60
FC-011-0605-F	6'	5'	\$ 87.00
FC-011-0606-F	6'	6'	\$ 104.40
FC-011-0607-F	6'	7'	\$ 121.80
FC-011-0608-F	6'	8'	\$ 139.20
FC-011-0609-F	6'	9'	\$ 156.60
FC-011-0610-F	6'	10'	\$ 174.00
FC-011-0611-F	6'	11'	\$ 191.40
FC-011-0612-F	6'	12'	\$ 208.80

#### Blanket Sizes No Grommets

Item #	Height	Width	Price
FB-011-0503	5'	3'	\$ 41.25
FB-011-0504	5'	4'	\$ 55.00
FB-011-0505	5'	5'	\$ 68.75
FB-011-0506	5'	6'	\$ 82.50
FB-011-0507	5'	7'	\$ 96.25
FB-011-0508	5'	8'	\$ 110.00
FB-011-0509	5'	9'	\$ 123.75
FB-011-0510	5'	10'	\$ 137.50
FB-011-0511	5'	11'	\$ 151.25
FB-011-0512	5'	12'	\$ 165.00
FB-011-0515	5'	15'	\$ 206.25
FB-011-1005	10'	5'	\$ 137.50
FB-011-1006	10'	6'	\$ 165.00
FB-011-1007	10'	7'	\$ 192.50
FB-011-1008	10'	8'	\$ 220.00
FB-011-1010	10'	10'	\$ 275.00
FB-011-1012	10'	12'	\$ 330.00
FB-011-1015	10'	15'	\$ 412.50
FB-011-1020	10'	20'	\$ 550.00
FB-011-1520	15'	20'	\$ 825.00



**INDUSTRIES INC.**

PO Box 7132  
London, Ontario  
N5Y 4J9

Tel: (519) 452-3780  
Fax: (519) 452-3053

# Safety Curtains

## 20oz Flame Resistant Cotton Duck

See Fabric # 012

### Description

A high quality grade flame resistant cotton duck cloth for general plant usage. Resistant to flame, water, mold and mildew. Applications include, grinding and welding curtains and light duty spark blankets.

### Sizes

Curtains are fabricated to any size with stitched seams and hems. Brass grommets can be installed on the top side on 12" centers or on all four sides on 12" centers.

### Ordering Information

Curtains and blankets can be ordered to any size. Specify fabric #, height x width and grommet location when ordering. Standard sizes are listed below with their respective item numbers.

### Pricing

Custom curtains with grommets on top only ..... \$ 3.30 per square foot  
Custom curtains with grommets on four sides ..... \$ 3.45 per square foot  
Custom Blankets - No Grommets ..... \$ 3.30 per square foot

#### Standard Sizes Grommets Top Only

Item #	Height	Width	Price
FC-012-0503-T	5'	3'	\$ 49.50
FC-012-0504-T	5'	4'	\$ 66.00
FC-012-0505-T	5'	5'	\$ 82.50
FC-012-0506-T	5'	6'	\$ 99.00
FC-012-0507-T	5'	7'	\$ 115.50
FC-012-0508-T	5'	8'	\$ 132.00
FC-012-0509-T	5'	9'	\$ 148.50
FC-012-0510-T	5'	10'	\$ 165.00
FC-012-0511-T	5'	11'	\$ 181.50
FC-012-0512-T	5'	12'	\$ 198.00
FC-012-0603-T	6'	3'	\$ 59.40
FC-012-0604-T	6'	4'	\$ 79.20
FC-012-0605-T	6'	5'	\$ 99.00
FC-012-0606-T	6'	6'	\$ 118.80
FC-012-0607-T	6'	7'	\$ 138.60
FC-012-0608-T	6'	8'	\$ 158.40
FC-012-0609-T	6'	9'	\$ 178.20
FC-012-0610-T	6'	10'	\$ 198.00
FC-012-0611-T	6'	11'	\$ 217.80
FC-012-0612-T	6'	12'	\$ 237.60

#### Standard Sizes Grommets 4 sides

Item #	Height	Width	Price
FC-012-0503-F	5'	3'	\$ 51.75
FC-012-0504-F	5'	4'	\$ 69.00
FC-012-0505-F	5'	5'	\$ 86.25
FC-012-0506-F	5'	6'	\$ 103.50
FC-012-0507-F	5'	7'	\$ 120.75
FC-012-0508-F	5'	8'	\$ 138.00
FC-012-0509-F	5'	9'	\$ 155.25
FC-012-0510-F	5'	10'	\$ 172.50
FC-012-0511-F	5'	11'	\$ 189.75
FC-012-0512-F	5'	12'	\$ 207.00
FC-012-0603-F	6'	3'	\$ 62.10
FC-012-0604-F	6'	4'	\$ 82.80
FC-012-0605-F	6'	5'	\$ 103.50
FC-012-0606-F	6'	6'	\$ 124.20
FC-012-0607-F	6'	7'	\$ 144.90
FC-012-0608-F	6'	8'	\$ 165.60
FC-012-0609-F	6'	9'	\$ 186.30
FC-012-0610-F	6'	10'	\$ 207.00
FC-012-0611-F	6'	11'	\$ 227.70
FC-012-0612-F	6'	12'	\$ 248.40

#### Blanket Sizes No Grommets

Item #	Height	Width	Price
FB-012-0503	5'	3'	\$ 49.50
FB-012-0504	5'	4'	\$ 66.00
FB-012-0505	5'	5'	\$ 82.50
FB-012-0506	5'	6'	\$ 99.00
FB-012-0507	5'	7'	\$ 115.50
FB-012-0508	5'	8'	\$ 132.00
FB-012-0509	5'	9'	\$ 148.50
FB-012-0510	5'	10'	\$ 165.00
FB-012-0511	5'	11'	\$ 181.50
FB-012-0512	5'	12'	\$ 198.00
FB-012-0515	5'	15'	\$ 247.50
FB-012-1005	10'	5'	\$ 165.00
FB-012-1006	10'	6'	\$ 198.00
FB-012-1007	10'	7'	\$ 231.00
FB-012-1008	10'	8'	\$ 264.00
FB-012-1010	10'	10'	\$ 330.00
FB-012-1012	10'	12'	\$ 396.00
FB-012-1015	10'	15'	\$ 495.00
FB-012-1020	10'	20'	\$ 660.00
FB-012-1520	15'	20'	\$ 990.00



**INDUSTRIES INC.**

PO Box 7132  
London, Ontario  
N5Y 4J9

Tel: (519) 452-3780  
Fax: (519) 452-3053

# Safety Curtains

## 16oz Vinyl-Poly

See Fabric # 013

### Description

A high quality tear resistant and flame resistant fabric well suited for general uses at normal ambient temperatures. The vinyl coating provides a good shedding feature and a surface that can be easily cleaned. This fabric is resistant to water, grease, oil, most chemicals and mildew.

### Sizes

Curtains are fabricated to any size with electronically sealed seams and hems on all four sides. Brass grommets can be installed on the top side on 12" centers or on all four sides on 12" centers.

### Ordering Information

Curtains can be ordered to any size. Specify fabric #, height x width, grommet location and colour when ordering. Standard sizes are listed below with their respective item numbers. Colours available: Green, Blue, Yellow, Black, White or Grey.

### Pricing

Custom curtains with grommets on top only ..... \$ 1.85 per square foot  
Custom curtains with grommets on four sides ..... \$ 2.00 per square foot

#### Standard Sizes Grommets Top Only

Item #	Height	Width	Price
FC-013-xxx-0503-T	5'	3'	\$ 27.75
FC-013-xxx-0504-T	5'	4'	\$ 37.00
FC-013-xxx-0505-T	5'	5'	\$ 46.25
FC-013-xxx-0506-T	5'	6'	\$ 55.50
FC-013-xxx-0507-T	5'	7'	\$ 64.75
FC-013-xxx-0508-T	5'	8'	\$ 74.00
FC-013-xxx-0509-T	5'	9'	\$ 83.25
FC-013-xxx-0510-T	5'	10'	\$ 92.50
FC-013-xxx-0511-T	5'	11'	\$ 101.75
FC-013-xxx-0512-T	5'	12'	\$ 111.00
FC-013-xxx-0603-T	6'	3'	\$ 33.30
FC-013-xxx-0604-T	6'	4'	\$ 44.40
FC-013-xxx-0605-T	6'	5'	\$ 55.50
FC-013-xxx-0606-T	6'	6'	\$ 66.60
FC-013-xxx-0607-T	6'	7'	\$ 77.70
FC-013-xxx-0608-T	6'	8'	\$ 88.80
FC-013-xxx-0609-T	6'	9'	\$ 99.90
FC-013-xxx-0610-T	6'	10'	\$ 111.00
FC-013-xxx-0611-T	6'	11'	\$ 122.10
FC-013-xxx-0612-T	6'	12'	\$ 133.20

#### Standard Sizes Grommets 4 sides

Item #	Height	Width	Price
FC-013-xxx-0503-F	5'	3'	\$ 30.00
FC-013-xxx-0504-F	5'	4'	\$ 40.00
FC-013-xxx-0505-F	5'	5'	\$ 50.00
FC-013-xxx-0506-F	5'	6'	\$ 60.00
FC-013-xxx-0507-F	5'	7'	\$ 70.00
FC-013-xxx-0508-F	5'	8'	\$ 80.00
FC-013-xxx-0509-F	5'	9'	\$ 90.00
FC-013-xxx-0510-F	5'	10'	\$ 100.00
FC-013-xxx-0511-F	5'	11'	\$ 110.00
FC-013-xxx-0512-F	5'	12'	\$ 120.00
FC-013-xxx-0603-F	6'	3'	\$ 36.00
FC-013-xxx-0604-F	6'	4'	\$ 48.00
FC-013-xxx-0605-F	6'	5'	\$ 60.00
FC-013-xxx-0606-F	6'	6'	\$ 72.00
FC-013-xxx-0607-F	6'	7'	\$ 84.00
FC-013-xxx-0608-F	6'	8'	\$ 96.00
FC-013-xxx-0609-F	6'	9'	\$ 108.00
FC-013-xxx-0610-F	6'	10'	\$ 120.00
FC-013-xxx-0611-F	6'	11'	\$ 132.00
FC-013-xxx-0612-F	6'	12'	\$ 144.00

**Example:** FC-013-xxx-0612T

XXX is replaced with a colour code.

GRN = Green    BLU = Blue    YEL = Yellow    BLK = Black    WHT = White    GRY = Grey



**INDUSTRIES INC.**

PO Box 7132  
London, Ontario  
N5Y 4J9

Tel: (519) 452-3780  
Fax: (519) 452-3053

# Safety Curtains

## 19oz Vinyl-Poly

See Fabric # 014

### Description

A high quality tear resistant and flame resistant fabric well suited for general uses at normal ambient temperatures. The vinyl coating provides a good shedding feature and a surface that can be easily cleaned. This fabric is resistant to water, grease, oil, most chemicals and mildew.

### Sizes

Curtains are fabricated to any size with electronically sealed seams and hems on all four sides. Brass grommets can be installed on the top side on 12" centers or on all four sides on 12" centers.

### Ordering Information

Curtains can be ordered to any size. Specify fabric #, height x width, grommet location, and colour when ordering. Standard sizes are listed below with their respective item numbers. Colours available: Red, Green, Blue, Yellow, Black or White.

### Pricing

Custom curtains with grommets on top only ..... \$ 2.75 per square foot  
Custom curtains with grommets on four sides ..... \$ 2.90 per square foot

#### Standard Sizes Grommets Top Only

Item #	Height	Width	Price
FC-014-xxx-0503-T	5'	3'	\$ 41.25
FC-014-xxx-0504-T	5'	4'	\$ 55.00
FC-014-xxx-0505-T	5'	5'	\$ 68.75
FC-014-xxx-0506-T	5'	6'	\$ 82.50
FC-014-xxx-0507-T	5'	7'	\$ 96.25
FC-014-xxx-0508-T	5'	8'	\$ 110.00
FC-014-xxx-0509-T	5'	9'	\$ 123.75
FC-014-xxx-0510-T	5'	10'	\$ 137.50
FC-014-xxx-0511-T	5'	11'	\$ 151.25
FC-014-xxx-0512-T	5'	12'	\$ 165.00
FC-014-xxx-0603-T	6'	3'	\$ 49.50
FC-014-xxx-0604-T	6'	4'	\$ 66.00
FC-014-xxx-0605-T	6'	5'	\$ 82.50
FC-014-xxx-0606-T	6'	6'	\$ 99.00
FC-014-xxx-0607-T	6'	7'	\$ 115.50
FC-014-xxx-0608-T	6'	8'	\$ 132.00
FC-014-xxx-0609-T	6'	9'	\$ 148.50
FC-014-xxx-0610-T	6'	10'	\$ 165.00
FC-014-xxx-0611-T	6'	11'	\$ 181.50
FC-014-xxx-0612-T	6'	12'	\$ 198.00

#### Standard Sizes Grommets 4 sides

Item #	Height	Width	Price
FC-014-xxx-0503-F	5'	3'	\$ 43.50
FC-014-xxx-0504-F	5'	4'	\$ 58.00
FC-014-xxx-0505-F	5'	5'	\$ 72.50
FC-014-xxx-0506-F	5'	6'	\$ 87.00
FC-014-xxx-0507-F	5'	7'	\$ 101.50
FC-014-xxx-0508-F	5'	8'	\$ 116.00
FC-014-xxx-0509-F	5'	9'	\$ 130.50
FC-014-xxx-0510-F	5'	10'	\$ 145.00
FC-014-xxx-0511-F	5'	11'	\$ 159.50
FC-014-xxx-0512-F	5'	12'	\$ 174.00
FC-014-xxx-0603-F	6'	3'	\$ 52.20
FC-014-xxx-0604-F	6'	4'	\$ 69.00
FC-014-xxx-0605-F	6'	5'	\$ 87.00
FC-014-xxx-0606-F	6'	6'	\$ 104.40
FC-014-xxx-0607-F	6'	7'	\$ 121.80
FC-014-xxx-0608-F	6'	8'	\$ 139.20
FC-014-xxx-0609-F	6'	9'	\$ 156.60
FC-014-xxx-0610-F	6'	10'	\$ 174.00
FC-014-xxx-0611-F	6'	11'	\$ 191.40
FC-014-xxx-0612-F	6'	12'	\$ 208.80

**Example:** FC-014-xxx-0612T

XXX is replaced with a colour code.

RED = Red      GRN = Green      BLU = Blue      YEL = Yellow      BLK = Black      WHT = White



**INDUSTRIES INC.**

PO Box 7132  
London, Ontario  
N5Y 4J9

Tel: (519) 452-3780  
Fax: (519) 452-3053

# Safety Curtains

## 13oz Translucent Reinforced Vinyl-Poly

See Fabric # 050

### Description

A high quality tear resistant and flame resistant fabric well suited for outdoor use with superior low temp performance and UV resistance for long life. The vinyl coating provides a good shedding feature and a surface that can be easily cleaned. This fabric is resistant to water, grease, oil, most chemicals and mildew.

### Sizes

Curtains are fabricated to any size with electronically sealed seams and hems on all four sides. Brass grommets can be installed on the top side on 12" centers or on all four sides on 12" centers.

### Ordering Information

Curtains can be ordered to any size. Specify fabric #, height x width, grommet location, and colour when ordering. Standard sizes are listed below with their respective item numbers.

### Pricing

Custom curtains with grommets on top only ..... \$ 1.75 per square foot  
Custom curtains with grommets on four sides ..... \$ 1.90 per square foot

### Standard Sizes Grommets Top Only

Item #	Height	Width	Price
FC-050-0503-T	5'	3'	\$ 26.25
FC-050-0504-T	5'	4'	\$ 35.00
FC-050-0505-T	5'	5'	\$ 43.75
FC-050-0506-T	5'	6'	\$ 52.50
FC-050-0507-T	5'	7'	\$ 61.25
FC-050-0508-T	5'	8'	\$ 70.00
FC-050-0509-T	5'	9'	\$ 78.75
FC-050-0510-T	5'	10'	\$ 87.50
FC-050-0511-T	5'	11'	\$ 96.25
FC-050-0512-T	5'	12'	\$ 105.00
FC-050-0603-T	6'	3'	\$ 31.50
FC-050-0604-T	6'	4'	\$ 42.00
FC-050-0605-T	6'	5'	\$ 52.50
FC-050-0606-T	6'	6'	\$ 63.00
FC-050-0607-T	6'	7'	\$ 73.50
FC-050-0608-T	6'	8'	\$ 84.00
FC-050-0609-T	6'	9'	\$ 94.50
FC-050-0610-T	6'	10'	\$ 105.00
FC-050-0611-T	6'	11'	\$ 115.50
FC-050-0612-T	6'	12'	\$ 126.00

### Standard Sizes Grommets 4 sides

Item #	Height	Width	Price
FC-050-0503-F	5'	3'	\$ 28.50
FC-050-0504-F	5'	4'	\$ 38.00
FC-050-0505-F	5'	5'	\$ 47.50
FC-050-0506-F	5'	6'	\$ 57.00
FC-050-0507-F	5'	7'	\$ 66.50
FC-050-0508-F	5'	8'	\$ 76.00
FC-050-0509-F	5'	9'	\$ 85.50
FC-050-0510-F	5'	10'	\$ 95.00
FC-050-0511-F	5'	11'	\$ 104.50
FC-050-0512-F	5'	12'	\$ 114.00
FC-050-0603-F	6'	3'	\$ 34.20
FC-050-0604-F	6'	4'	\$ 45.60
FC-050-0605-F	6'	5'	\$ 57.00
FC-050-0606-F	6'	6'	\$ 68.40
FC-050-0607-F	6'	7'	\$ 79.80
FC-050-0608-F	6'	8'	\$ 91.20
FC-050-0609-F	6'	9'	\$ 102.60
FC-050-0610-F	6'	10'	\$ 114.00
FC-050-0611-F	6'	11'	\$ 125.40
FC-050-0612-F	6'	12'	\$ 136.80





**INDUSTRIES INC.**

PO Box 7132  
London, Ontario  
N5Y 4J9

Tel: (519) 452-3780  
Fax: (519) 452-3053

# Safety Curtains

## 19oz Neony

See Fabric # 015

### Description

Neony is a heavy duty black neoprene coated nylon fabric designed for tough, ambient temperatures applications. This fabric is highly resistant to punctures, tearing, abrasion, flame, sparks and most acids, as well as cold weather. Ideal as indoor or outdoor tarps and covers and general shop curtains.

### Sizes

Curtains are fabricated to any size with stitched seams and hems. Brass grommets can be installed on the top side on 12" centers or on all four sides on 12" centers.

### Ordering Information

Curtains and covers can be ordered to any size. Specify fabric #, height x width and grommet location when ordering.

### Pricing

Custom curtains with grommets on top only .....	\$ 5.65 per square foot
Custom curtains with grommets on four sides .....	\$ 5.90 per square foot

## 40oz Neony

See Fabric # 016

### Description

Neony is a heavy duty black neoprene coated nylon fabric designed for tough, ambient temperatures applications. This fabric is highly resistant to punctures, tearing, abrasion, sparks and most acids, as well as cold weather. Ideal as indoor or outdoor tarps and covers and general shop curtains.

### Sizes

Curtains are fabricated to any size with stitched seams and hems. Brass grommets can be installed on the top side on 12" centers or on all four sides on 12" centers.

### Ordering Information

Curtains and covers can be ordered to any size. Specify fabric #, height x width and grommet location when ordering.

### Pricing

Curtains with grommets on top only .....	\$ 7.75 per square foot
Curtains with grommets on four sides .....	\$ 8.00 per square foot



**INDUSTRIES INC.**

PO Box 7132  
London, Ontario  
N5Y 4J9

Tel: (519) 452-3780  
Fax: (519) 452-3053

# Safety Blankets

## 22oz Goldengard

See Fabric # 017

### Description

Designed as a general purpose safety fabric, this glass cloth is slightly rubberized to prevent absorption of oils and such in a shop environment. The light neoprene coating also enhances abrasion resistance, and it's economical price makes it a popular replacement for conventional asbestos. With a service temperature to 1000° F, typical applications are heat curtains, spray shields and light to medium duty welding blankets.

### Fabrication

Blankets fabricated to any size with stitched seams and hems, using high temperature aramid thread.

### Sizes

Blankets can be ordered to any size. Specify fabric # and height x width. Standard sizes are listed below with their respective item numbers.

### Pricing

Custom Blankets ..... \$ 5.20 per square foot

### Standard Sizes

Item #	Height	Width	Price
FB-017-0503	5'	3'	\$ 78.00
FB-017-0504	5'	4'	\$ 104.00
FB-017-0505	5'	5'	\$ 130.00
FB-017-0506	5'	6'	\$ 156.00
FB-017-0507	5'	7'	\$ 182.00
FB-017-0508	5'	8'	\$ 208.00
FB-017-0509	5'	9'	\$ 234.00
FB-017-0510	5'	10'	\$ 260.00
FB-017-0511	5'	11'	\$ 286.00
FB-017-0512	5'	12'	\$ 312.00
FB-017-0603	6'	3'	\$ 93.60
FB-017-0604	6'	4'	\$ 124.80
FB-017-0606	6'	6'	\$ 187.20
FB-017-0607	6'	7'	\$ 218.40
FB-017-0608	6'	8'	\$ 249.60
FB-017-0609	6'	9'	\$ 280.80
FB-017-0610	6'	10'	\$ 312.00
FB-017-0611	6'	11'	\$ 343.20
FB-017-0612	6'	12'	\$ 374.40
FB-017-0810	8'	10'	\$ 416.00
FB-017-1010	10'	10'	\$ 520.00
FB-017-1012	10'	12'	\$ 624.00
FB-017-1015	10'	15'	\$ 780.00



**INDUSTRIES INC.**

PO Box 7132  
London, Ontario  
N5Y 4J9

Tel: (519) 452-3780  
Fax: (519) 452-3053

# Safety Blankets

## 30oz Goldengard

See Fabric # 018

### Description

Designed as a general purpose safety fabric, this glass cloth is slightly rubberized to prevent absorption of oils and such in a shop environment. The light neoprene coating also enhances abrasion resistance, and it's economical price makes it a popular replacement for conventional asbestos. With a service temperature to 1000° F, typical applications are heat curtains, spray shields and medium duty welding blankets.

### Fabrication

Blankets fabricated to any size with stitched seams and hems, using high temperature aramid thread.

### Sizes

Blankets can be ordered to any size. Specify fabric # and height x width. Standard sizes are listed below with their respective item numbers.

### Pricing

Custom Blankets ..... \$ 6.80 per square foot

### Standard Sizes

Item #	Height	Width	Price
FB-018-0503	5'	3'	\$ 102.00
FB-018-0504	5'	4'	\$ 136.00
FB-018-0505	5'	5'	\$ 170.00
FB-018-0506	5'	6'	\$ 204.00
FB-018-0507	5'	7'	\$ 238.00
FB-018-0508	5'	8'	\$ 272.00
FB-018-0509	5'	9'	\$ 306.00
FB-018-0510	5'	10'	\$ 340.00
FB-018-0511	5'	11'	\$ 374.00
FB-018-0512	5'	12'	\$ 408.00
FB-018-0603	6'	3'	\$ 122.40
FB-018-0604	6'	4'	\$ 163.20
FB-018-0606	6'	6'	\$ 244.80
FB-018-0607	6'	7'	\$ 285.60
FB-018-0608	6'	8'	\$ 326.40
FB-018-0609	6'	9'	\$ 367.20
FB-018-0610	6'	10'	\$ 408.00
FB-018-0611	6'	11'	\$ 448.80
FB-018-0612	6'	12'	\$ 489.60
FB-018-0810	8'	10'	\$ 544.00
FB-018-1010	10'	10'	\$ 680.00
FB-018-1012	10'	12'	\$ 816.00
FB-018-1015	10'	15'	\$1020.00



**INDUSTRIES INC.**

PO Box 7132  
London, Ontario  
N5Y 4J9

Tel: (519) 452-3780  
Fax: (519) 452-3053

# Safety Blankets

## 22oz Aramid

See Fabric # 019

### Description

An aramid blend heat resistant fabric that is extra tough, extra flexible and extra clean. It has superior abrasion resistance, high tear strength and excellent dimensional stability. It is a non-itching, non-irritating fabric that is particularly good as a high temperature cloth that requires constant handling. Aramid offers an excellent resistance to acids and alkalis, will not deteriorate with age and will not mildew. With a service temperature to 650° F, typical applications are heat pads, wear apparel, fire blankets and curtains.

### Fabrication

Blankets fabricated to any size with stitched seams and hems, using high temperature aramid thread.

### Sizes

Blankets can be ordered to any size. Specify fabric # and height x width. Standard sizes are listed below with their respective item numbers.

### Pricing

Custom Blankets ..... \$ 10.30 per square foot

### Standard Sizes

Item #	Height	Width	Price
FB-019-0503	5'	3'	\$ 154.50
FB-019-0504	5'	4'	\$ 206.00
FB-019-0505	5'	5'	\$ 257.50
FB-019-0506	5'	6'	\$ 309.00
FB-019-0507	5'	7'	\$ 360.50
FB-019-0508	5'	8'	\$ 412.00
FB-019-0509	5'	9'	\$ 463.50
FB-019-0510	5'	10'	\$ 515.00
FB-019-0511	5'	11'	\$ 566.50
FB-019-0512	5'	12'	\$ 618.00
FB-019-0603	6'	3'	\$ 185.40
FB-019-0604	6'	4'	\$ 247.20
FB-019-0606	6'	6'	\$ 370.80
FB-019-0607	6'	7'	\$ 432.60
FB-019-0608	6'	8'	\$ 494.40
FB-019-0609	6'	9'	\$ 556.20
FB-019-0610	6'	10'	\$ 618.00
FB-019-0611	6'	11'	\$ 679.80
FB-019-0612	6'	12'	\$ 741.60
FB-019-0810	8'	10'	\$ 824.00
FB-019-1010	10'	10'	\$ 1030.00
FB-019-1012	10'	12'	\$ 1236.00
FB-019-1015	10'	15'	\$ 1545.00



**INDUSTRIES INC.**

PO Box 7132  
London, Ontario  
N5Y 4J9

Tel: (519) 452-3780  
Fax: (519) 452-3053

# Safety Blankets

## 23oz Weldflex

See Fabric # 020

### Description

Weldflex is a specially coated cloth made from a combination of aramid and glass fibres and treated to enhance the shedding of molten metal splash generated by the most severe welding or furnace operations. Weldflex is highly abrasion resistant, has exceptional strength and durability, good heat resistance, yet is soft, pliable and non-irritating. Weldflex sheds welding spatter and molten metal up to 3000° F on a 15° to 20° incline. With a service temperature to 650° F, Weldflex makes an excellent welding blanket or spray shield.

### Fabrication

Blankets fabricated to any size with stitched seams and hems, using high temperature aramid thread.

### Sizes

Blankets can be ordered to any size. Specify fabric # and height x width. Standard sizes are listed below with their respective item numbers.

### Pricing

Custom Blankets ..... \$ 10.40 per square foot

### Standard Sizes

Item #	Height	Width	Price
FB-020-0503	5'	3'	\$ 156.00
FB-020-0504	5'	4'	\$ 208.00
FB-020-0505	5'	5'	\$ 260.00
FB-020-0506	5'	6'	\$ 312.00
FB-020-0507	5'	7'	\$ 364.00
FB-020-0508	5'	8'	\$ 416.00
FB-020-0509	5'	9'	\$ 468.00
FB-020-0510	5'	10'	\$ 520.00
FB-020-0511	5'	11'	\$ 572.00
FB-020-0512	5'	12'	\$ 624.00
FB-020-0603	6'	3'	\$ 187.20
FB-020-0604	6'	4'	\$ 249.60
FB-020-0606	6'	6'	\$ 374.40
FB-020-0607	6'	7'	\$ 436.80
FB-020-0608	6'	8'	\$ 499.20
FB-020-0609	6'	9'	\$ 564.60
FB-020-0610	6'	10'	\$ 624.00
FB-020-0611	6'	11'	\$ 686.40
FB-020-0612	6'	12'	\$ 748.80
FB-020-0810	8'	10'	\$ 832.00
FB-020-1010	10'	10'	\$ 1040.00
FB-020-1012	10'	12'	\$ 1248.00
FB-020-1015	10'	15'	\$ 1560.00

## Safety Blankets

### 16oz Carbon Felt

See Fabric # 021

#### Description

Carbon Felt is made from organic carbon fibre and is designed to provide protection in high temperature applications such as brazing, soldering and light welding. Carbon Felt is highly flame, heat and chemical resistant. It is non-flammable, non-melting and non-shrinking. It is amazingly soft, lightweight and flexible which allows it to be wrapped around pipes, stuffed into tight spots, or draped over objects that need to be protected from sparks, heat or flame. Carbon Felt withstands continuous temperatures up to 1800° F and short duration temperatures up to 2500° F with minimal heat transfer taking place between the blanket and the protected surface. Carbon Felt is ideal for autobody, plumbing and light welding applications.

The Carbon Felt AGO Torch Shield (shown below) is ideal for protecting walls, joists, and wall studs from burn damage associated with soldering. Torch Shield is a must for every tool box.

#### Fabrication

Blankets fabricated to any size with stitched seams using high temperature aramid thread. No hems are required as this material does not fray. Grommets are not suitable in this fabric.

#### Sizes

Blankets can be ordered to any size. Specify fabric # and height x width. Standard sizes are listed below with their respective item numbers.

#### Pricing

Custom Blankets ..... \$ 7.20 per square foot

#### Standard Blanket Sizes

Item #	Height	Width	Price
FB-021-0503	5'	3'	\$ 108.00
FB-021-0504	5'	4'	\$ 144.00
FB-021-0505	5'	5'	\$ 180.00
FB-021-0506	5'	6'	\$ 216.00
FB-021-0507	5'	7'	\$ 252.00
FB-021-0508	5'	8'	\$ 288.00
FB-021-0509	5'	9'	\$ 324.00
FB-021-0510	5'	10'	\$ 360.00
FB-021-0511	5'	11'	\$ 396.00
FB-021-0512	5'	12'	\$ 432.00
FB-021-0513	5'	13'	\$ 468.00
FB-021-0514	5'	14'	\$ 504.00
FB-021-0515	5'	15'	\$ 540.00
FB-021-1010	10'	10'	\$ 720.00
FB-021-1012	10'	12'	\$ 864.00
FB-021-1015	10'	15'	\$1080.00

#### Pre-Packaged 12" x 20" Torch Shield



CG-050-1	Single	\$ 28.85
CG-050-10	Ten Pack	\$288.75



**INDUSTRIES INC.**

PO Box 7132  
London, Ontario  
N5Y 4J9

Tel: (519) 452-3780  
Fax: (519) 452-3053

# Safety Curtains

## 17oz Heatstop

See Fabric # 022

### Description

A silicone impregnated glass cloth designed to handle severe conditions in the industrial work place. The special non-combustible silicone rubber provides greater life and improved resistance to abrasion, flexing, tear and puncture. This material passes all tests for intoxicating fumes, meets federal standards and OSHA specifications. The silicone coating sheds molten metal splash and will not absorb oils, grease or water. With an operating temperature to 500° F, Heatstop is excellent for vertical spray and splash shield applications.

### Fabrication

Curtains fabricated to any size with stitched seams and hems on all four sides, using high temperature aramid thread.

### Sizes

Curtains can be ordered to any size. Specify fabric #, height x width and grommet location when ordering.

### Pricing

Custom curtains with grommets top only .....	\$ 5.00 per square foot
Custom curtains with grommets four sides .....	\$ 5.25 per square foot

## 32oz Heatstop

See Fabric # 023

### Description

A silicone impregnated glass cloth designed to handle severe conditions in the industrial work place. The special non-combustible silicone rubber provides greater life and improved resistance to abrasion, flexing, tear and puncture. This material passes all tests for intoxicating fumes, meets federal standards and OSHA specifications. The silicone coating sheds molten metal splash and will not absorb oils, grease or water. With an operating temperature to 500° F, Heatstop is excellent for vertical spray and splash shield applications.

### Fabrication

Curtains fabricated to any size with stitched seams and hems on all four sides, using high temperature aramid thread.

### Sizes

Curtains can be ordered to any size. Specify fabric #, height x width and grommet location when ordering.

### Pricing

Custom curtains with grommets top only .....	\$ 7.75 per square foot
Custom curtains with grommets four sides .....	\$ 8.00 per square foot



**INDUSTRIES INC.**

PO Box 7132  
London, Ontario  
N5Y 4J9

Tel: (519) 452-3780  
Fax: (519) 452-3053

# Safety Blankets

## 18oz Agotex # 600

See Fabric # 024

### Description

Agotex is a soft, flexible cloth woven from a highly texturized form of fibreglass with higher temperature capability and better molten metal splash resistance. Agotex withstands continuous temperatures up to 1100° F and higher short duration temperatures and withstands cold to -100° F. Agotex has high dielectric strength and resists most acids, alkalis and solvents. A very strong fabric with good insulating properties, Agotex is an excellent alternative to conventional asbestos for welding, drop, fire and oven curtains, stress relieving blankets, thermal insulation, welding and safety blankets and industrial insulations. Colour is safety red.

### Fabrication

Blankets can be fabricated to any size with stitched seams and hems on all four sides, using high temperature aramid thread. Optional brass grommets can be installed on custom blankets if required.

### Sizes

Blankets can be ordered to any size. Specify fabric # and height x width when ordering. Standard blanket sizes are listed below with their respective item numbers.

### Pricing

Custom Blankets ..... \$ 3.95 per square foot

## Standard Blanket Sizes

Item #	Height	Width	Price
FB-024-0503	5'	3'	\$ 59.25
FB-024-0504	5'	4'	\$ 79.00
FB-024-0505	5'	5'	\$ 98.75
FB-024-0506	5'	6'	\$ 118.50
FB-024-0507	5'	7'	\$ 138.25
FB-024-0508	5'	8'	\$ 158.00
FB-024-0509	5'	9'	\$ 177.75
FB-024-0510	5'	10'	\$ 197.50
FB-024-0511	5'	11'	\$ 217.25
FB-024-0512	5'	12'	\$ 237.00
FB-024-0514	5'	14'	\$ 276.50
FB-024-0515	5'	15'	\$ 296.25

Item #	Height	Width	Price
FB-024-0604	6'	4'	\$ 94.80
FB-024-0606	6'	6'	\$ 142.20
FB-024-0607	6'	7'	\$ 165.90
FB-024-0608	6'	8'	\$ 189.60
FB-024-0609	6'	9'	\$ 213.30
FB-024-0610	6'	10'	\$ 237.00
FB-024-0611	6'	11'	\$ 260.70
FB-024-0612	6'	12'	\$ 284.40
FB-024-0810	8'	10'	\$ 316.00
FB-024-1010	10'	10'	\$ 395.00
FB-024-1012	10'	12'	\$ 474.00
FB-024-1015	10'	15'	\$ 592.50





**INDUSTRIES INC.**

PO Box 7132  
London, Ontario  
N5Y 4J9

Tel: (519) 452-3780  
Fax: (519) 452-3053

# Safety Blankets

## 24oz Agotex # 800

See Fabric # 025

### Description

Agotex is a soft, flexible cloth woven from a highly texturized form of fibreglass with higher temperature capability and better molten metal splash resistance. Agotex withstands continuous temperatures up to 1100° F and higher short duration temperatures and withstands cold to -100° F. Agotex has high dielectric strength and resists most acids, alkalis and solvents. A very strong fabric with good insulating properties, Agotex is an excellent alternative to conventional asbestos for welding, drop, fire and oven curtains, stress relieving blankets, thermal insulation, welding and safety blankets and industrial insulations. Colour is safety orange.

### Fabrication

Blankets can be fabricated to any size with stitched seams and hems on all four sides, using high temperature aramid thread. Optional brass grommets can be installed on custom blankets if required.

### Sizes

Blankets can be ordered to any size. Specify fabric # and height x width when ordering. Standard blanket sizes are listed below with their respective item numbers.

### Pricing

Custom Blankets ..... \$ 5.55 per square foot

## Standard Blanket Sizes

Item #	Height	Width	Price
FB-025-0503	5'	3'	\$ 83.25
FB-025-0504	5'	4'	\$ 111.00
FB-025-0505	5'	5'	\$ 138.75
FB-025-0506	5'	6'	\$ 166.50
FB-025-0507	5'	7'	\$ 194.25
FB-025-0508	5'	8'	\$ 222.00
FB-025-0509	5'	9'	\$ 249.75
FB-025-0510	5'	10'	\$ 277.50
FB-025-0511	5'	11'	\$ 305.25
FB-025-0512	5'	12'	\$ 333.00
FB-025-0514	5'	14'	\$ 388.50
FB-025-0515	5'	15'	\$ 416.25

Item #	Height	Width	Price
FB-025-0603	6'	3'	\$ 99.90
FB-025-0604	6'	4'	\$ 133.20
FB-025-0606	6'	6'	\$ 199.80
FB-025-0607	6'	7'	\$ 233.10
FB-025-0608	6'	8'	\$ 266.40
FB-025-0609	6'	9'	\$ 299.70
FB-025-0610	6'	10'	\$ 333.00
FB-025-0611	6'	11'	\$ 366.30
FB-025-0612	6'	12'	\$ 399.60
FB-025-0810	8'	10'	\$ 444.00
FB-025-1010	10'	10'	\$ 555.00
FB-025-1012	10'	12'	\$ 666.00



**INDUSTRIES INC.**

PO Box 7132  
London, Ontario  
N5Y 4J9

Tel: (519) 452-3780  
Fax: (519) 452-3053

# Safety Blankets

## 30oz Agotex # 1000

See Fabric # 026

### Description

Agotex is a soft, flexible cloth woven from a highly texturized form of fibreglass with higher temperature capability and better molten metal splash resistance. Agotex withstands continuous temperatures up to 1100° F and higher short duration temperatures and withstands cold to -100° F. Agotex has high dielectric strength and resists most acids, alkalis and solvents. A very strong fabric with good insulating properties, Agotex is an excellent alternative to conventional asbestos for welding, drop, fire and oven curtains, stress relieving blankets, thermal insulation, welding and safety blankets and industrial insulations.

### Fabrication

Blankets can be fabricated to any size with stitched seams and hems on all four sides, using high temperature aramid thread. Optional brass grommets can be installed on custom blankets if required.

### Sizes

Blankets can be ordered to any size. Specify fabric # and height x width when ordering. Standard blanket sizes are listed below with their respective item numbers.

### Pricing

Custom Blankets ..... \$ 6.20 per square foot

## Standard Blanket Sizes

Item #	Height	Width	Price
FB-026-0503	5'	3'	\$ 93.00
FB-026-0504	5'	4'	\$ 124.00
FB-026-0505	5'	5'	\$ 155.00
FB-026-0506	5'	6'	\$ 186.00
FB-026-0507	5'	7'	\$ 217.00
FB-026-0508	5'	8'	\$ 248.00
FB-026-0509	5'	9'	\$ 279.00
FB-026-0510	5'	10'	\$ 310.00
FB-026-0511	5'	11'	\$ 341.00
FB-026-0512	5'	12'	\$ 372.00
FB-026-0514	5'	14'	\$ 434.00
FB-026-0515	5'	15'	\$ 465.00

Item #	Height	Width	Price
FB-026-0603	6'	3'	\$ 111.60
FB-026-0604	6'	4'	\$ 148.80
FB-026-0606	6'	6'	\$ 223.20
FB-026-0607	6'	7'	\$ 260.40
FB-026-0608	6'	8'	\$ 297.60
FB-026-0609	6'	9'	\$ 334.80
FB-026-0610	6'	10'	\$ 372.00
FB-026-0611	6'	11'	\$ 409.20
FB-026-0612	6'	12'	\$ 446.40
FB-026-0810	8'	10'	\$ 496.00
FB-026-1010	10'	10'	\$ 620.00
FB-026-1012	10'	12'	\$ 744.00



**INDUSTRIES INC.**

PO Box 7132  
London, Ontario  
N5Y 4J9

Tel: (519) 452-3780  
Fax: (519) 452-3053

# Safety Blankets

## 35oz Agotex # 1200

See Fabric # 027

### Description

Agotex is a soft, flexible cloth woven from a highly texturized form of fibreglass with higher temperature capability and better molten metal splash resistance. Agotex withstands continuous temperatures up to 1100° F and higher short duration temperatures and withstands cold to -100° F. Agotex has high dielectric strength and resists most acids, alkalies and solvents. A very strong fabric with good insulating properties, Agotex is an excellent alternative to conventional asbestos for welding, drop, fire and oven curtains, stress relieving blankets, thermal insulation, welding and safety blankets and industrial insulations.

### Fabrication

Blankets can be fabricated to any size with stitched seams and hems on all four sides, using high temperature aramid thread. Optional brass grommets can be installed on custom blankets if required.

### Sizes

Blankets can be ordered to any size. Specify fabric # and height x width when ordering. Standard blanket sizes are listed below with their respective item numbers.

### Pricing

Custom Blankets ..... \$ 6.85 per square foot

### Standard Blanket Sizes

Item #	Height	Width	Price
FB-027-0503	5'	3'	\$ 102.75
FB-027-0504	5'	4'	\$ 137.00
FB-027-0505	5'	5'	\$ 171.25
FB-027-0506	5'	6'	\$ 205.50
FB-027-0507	5'	7'	\$ 239.75
FB-027-0508	5'	8'	\$ 274.00
FB-027-0509	5'	9'	\$ 308.25
FB-027-0510	5'	10'	\$ 342.50
FB-027-0511	5'	11'	\$ 376.75
FB-027-0512	5'	12'	\$ 411.00
FB-027-0810	8'	10'	\$ 548.00
FB-027-1010	10'	10'	\$ 685.00
FB-027-1012	10'	12'	\$ 822.00



**INDUSTRIES INC.**

PO Box 7132  
London, Ontario  
N5Y 4J9

Tel: (519) 452-3780  
Fax: (519) 452-3053

# Safety Blankets

## 40oz Agotex # 1500

See Fabric # 028

### Description

Agotex is a soft, flexible cloth woven from a highly texturized form of fibreglass with higher temperature capability and better molten metal splash resistance. Agotex withstands continuous temperatures up to 1100° F and higher short duration temperatures and withstands cold to -100° F. Agotex has high dielectric strength and resists most acids, alkalies and solvents. A very strong fabric with good insulating properties, Agotex is an excellent alternative to conventional asbestos for welding, drop, fire and oven curtains, stress relieving blankets, thermal insulation, welding and safety blankets and industrial insulations.

### Fabrication

Blankets can be fabricated to any size with stitched seams and hems on all four sides, using high temperature aramid thread. Optional brass grommets can be installed on custom blankets if required.

### Sizes

Blankets can be ordered to any size. Specify fabric # and height x width when ordering. Standard blanket sizes are listed below with their respective item numbers.

### Pricing

Custom Blankets ..... \$ 7.50 per square foot

### Standard Blanket Sizes

Item #	Height	Width	Price
FB-028-0503	5'	3'	\$ 112.50
FB-028-0504	5'	4'	\$ 150.00
FB-028-0505	5'	5'	\$ 187.50
FB-028-0506	5'	6'	\$ 225.00
FB-028-0507	5'	7'	\$ 262.50
FB-028-0508	5'	8'	\$ 300.00
FB-028-0509	5'	9'	\$ 337.50
FB-028-0510	5'	10'	\$ 375.00
FB-028-0511	5'	11'	\$ 412.50
FB-028-0512	5'	12'	\$ 450.00
FB-028-0810	8'	10'	\$ 600.00
FB-028-1010	10'	10'	\$ 750.00
FB-028-1012	10'	12'	\$ 900.00



**INDUSTRIES INC.**

PO Box 7132  
London, Ontario  
N5Y 4J9

Tel: (519) 452-3780  
Fax: (519) 452-3053

# Safety Blankets

## 60oz Agotex # 2000

See Fabric # 029

### Description

Agotex is a soft, flexible cloth woven from a highly texturized form of fibreglass with higher temperature capability and better molten metal splash resistance. Agotex withstands continuous temperatures up to 1100° F and higher short duration temperatures and withstands cold to -100° F. Agotex has high dielectric strength and resists most acids, alkalis and solvents. A very strong fabric with good insulating properties, Agotex is an excellent alternative to conventional asbestos for welding, drop, fire and oven curtains, stress relieving blankets, thermal insulation, welding and safety blankets and industrial insulations.

### Fabrication

Blankets can be fabricated to any size with stitched seams and hems on all four sides, using high temperature aramid thread. Optional brass grommets can be installed on custom blankets if required.

### Sizes

Blankets can be ordered to any size. Specify fabric # and height x width when ordering. Standard blanket sizes are listed below with their respective item numbers.

### Pricing

Custom Blankets ..... \$ 11.15 per square foot

### Standard Blanket Sizes

Item #	Height	Width	Price
FB-029-0503	5'	3'	\$ 167.25
FB-029-0504	5'	4'	\$ 223.00
FB-029-0505	5'	5'	\$ 278.75
FB-029-0506	5'	6'	\$ 334.50
FB-029-0507	5'	7'	\$ 390.25
FB-029-0508	5'	8'	\$ 446.00
FB-029-0509	5'	9'	\$ 501.75
FB-029-0510	5'	10'	\$ 557.50
FB-029-0511	5'	11'	\$ 613.25
FB-029-0512	5'	12'	\$ 669.00
FB-029-0810	8'	10'	\$ 892.00
FB-029-1010	10'	10'	\$1115.00
FB-029-1012	10'	12'	\$1338.00



**INDUSTRIES INC.**

PO Box 7132  
London, Ontario  
N5Y 4J9

Tel: (519) 452-3780  
Fax: (519) 452-3053

# Safety Blankets

## 31oz Agotex Plus # 1000-P

See Fabric # 030

### Description

Agotex is a flexible cloth woven from a highly texturized form of fibreglass then treated with a patented vermiculite coating which enhances it's resistance to high temperatures and molten metal splash. The vermiculite coating makes this fabric suitable for molten metal splash protection as it is able to dissipate heat radically across the fabric so as not to allow it to concentrate in one spot. Agotex Plus has very good insulating properties and is an excellent choice for welding and splash blankets. Service to 1500° F and higher intermittent temperatures.

### Fabrication

Blankets can be fabricated to any size with stitched seams and hems on all four sides, using high temperature aramid thread. Optional brass grommets can be installed on custom blankets if required.

### Sizes

Blankets can be ordered to any size. Specify fabric # and height x width when ordering. Standard blanket sizes are listed below with their respective item numbers.

### Pricing

Custom Blankets ..... \$ 8.50 per square foot

### Standard Blanket Sizes

Item #	Height	Width	Price
FB-030-0503	5'	3'	\$ 127.50
FB-030-0504	5'	4'	\$ 170.00
FB-030-0505	5'	5'	\$ 212.50
FB-030-0506	5'	6'	\$ 255.00
FB-030-0507	5'	7'	\$ 297.50
FB-030-0508	5'	8'	\$ 340.00
FB-030-0509	5'	9'	\$ 382.50
FB-030-0510	5'	10'	\$ 425.00
FB-030-0511	5'	11'	\$ 467.50
FB-030-0512	5'	12'	\$ 510.00
FB-030-0810	8'	10'	\$ 680.00
FB-030-1010	10'	10'	\$ 850.00
FB-030-1012	10'	12'	\$1020.00



**INDUSTRIES INC.**

PO Box 7132  
London, Ontario  
N5Y 4J9

Tel: (519) 452-3780  
Fax: (519) 452-3053

# Safety Blankets

## Ago-Sil # 1800

See Fabric # 034

### Description

Ago-Sil is a highly texturized silica cloth made of a minimum 96% amorphous silicon dioxide. A special proprietary treatment reduces dusting and improves handling and abrasion resistance. Ago-Sil has a melt temperature exceeding 3100° F. It provides sustained protection against high heat conditions and is highly resistant to molten metal splash. Ago-Sil has superior thermal insulating properties enhanced by a high moisture absorption capacity which adds to its insulation capabilities without degradation of properties. It has a rapid heat dissipation factor and a very low thermal conductivity. Ago-Sil offers excellent electrical resistance. As well, it has excellent resistance to and compatibility with most chemicals. Ago-Sil is very flexible with excellent drapability and offers a wide versatility of use in industry with a service temperature to 2000° F. Applications include drop curtains for 'hot work' such as welding and burning, thermal and electrical insulation, stress relieving and curtains in front of furnace and oven openings. A host of miscellaneous jobs such as tray covers, pipe lagging, belting and sleeves, etc., can be handled by this high temperature cloth.

### Fabrication

Blankets can be fabricated to any size with stitched seams and hems on all four sides, using high temperature aramid thread. Optional brass grommets can be installed on custom blankets if required.

### Sizes

Blankets can be ordered to any size. Specify fabric #, height x width (and grommet location if required) when ordering. Standard blanket sizes are listed below with their respective item numbers.

### Pricing

Custom Blankets ..... \$ 7.25 per square foot

### Standard Blanket Sizes

Item #	Height	Width	Price
FB-034-0303	3'	3'	\$ 65.25
FB-034-0304	3'	4'	\$ 87.00
FB-034-0305	3'	5'	\$ 108.75
FB-034-0306	3'	6'	\$ 130.50
FB-034-0307	3'	7'	\$ 152.25
FB-034-0308	3'	8'	\$ 174.00
FB-034-0309	3'	9'	\$ 195.75
FB-034-0310	3'	10'	\$ 217.50
FB-034-0311	3'	11'	\$ 239.25
FB-034-0312	3'	12'	\$ 261.00

Item #	Height	Width	Price
FB-034-0603	6'	3'	\$ 130.50
FB-034-0604	6'	4'	\$ 174.00
FB-034-0605	6'	5'	\$ 217.50
FB-034-0606	6'	6'	\$ 261.00
FB-034-0607	6'	7'	\$ 304.50
FB-034-0608	6'	8'	\$ 348.00
FB-034-0609	6'	9'	\$ 391.50
FB-034-0610	6'	10'	\$ 435.00
FB-034-0611	6'	11'	\$ 478.50
FB-034-0612	6'	12'	\$ 522.00



**INDUSTRIES INC.**

PO Box 7132  
London, Ontario  
N5Y 4J9

Tel: (519) 452-3780  
Fax: (519) 452-3053

# Safety Blankets

## 41oz Agotex Plus # 1500-P

See Fabric # 032

### Description

Agotex is a flexible cloth woven from a highly texturized form of fibreglass then treated with a patented vermiculite coating which enhances it's resistance to high temperatures and molten metal splash. The vermiculite coating makes this fabric suitable for molten metal splash protection as it is able to dissipate heat radically across the fabric so as not to allow it to concentrate in one spot. Agotex Plus has very good insulating properties and is an excellent choice for welding and splash blankets. Service to 1500° F and higher intermittent temperatures.

### Fabrication

Blankets can be fabricated to any size with stitched seams and hems on all four sides, using high temperature aramid thread. Optional brass grommets can be installed on custom blankets if required.

### Sizes

Blankets can be ordered to any size. Specify fabric # and height x width when ordering. Standard blanket sizes are listed below with their respective item numbers.

### Pricing

Custom Blankets ..... \$ 9.80 per square foot

### Standard Blanket Sizes

Item #	Height	Width	Price
FB-032-0503	5'	3'	\$ 147.00
FB-032-0504	5'	4'	\$ 196.00
FB-032-0505	5'	5'	\$ 245.00
FB-032-0506	5'	6'	\$ 294.00
FB-032-0507	5'	7'	\$ 343.00
FB-032-0508	5'	8'	\$ 392.00
FB-032-0509	5'	9'	\$ 441.00
FB-032-0510	5'	10'	\$ 490.00
FB-032-0511	5'	11'	\$ 539.00
FB-032-0512	5'	12'	\$ 588.00
FB-032-0810	8'	10'	\$ 784.00
FB-032-1010	10'	10'	\$ 980.00
FB-032-1012	10'	12'	\$1176.00





**INDUSTRIES INC.**

PO Box 7132  
London, Ontario  
N5Y 4J9

Tel: (519) 452-3780  
Fax: (519) 452-3053

# Safety Blankets

## Ago-Sil # 3600

See Fabric # 035

### Description

Ago-Sil is a highly texturized silica cloth made of a minimum 96% amorphous silicon dioxide. A special proprietary treatment reduces dusting and improves handling and abrasion resistance. Ago-Sil has a melt temperature exceeding 3100° F. It provides sustained protection against high heat conditions and is highly resistant to molten metal splash. Ago-Sil has superior thermal insulating properties enhanced by a high moisture absorption capacity which adds to its insulation capabilities without degradation of properties. It has a rapid heat dissipation factor and a very low thermal conductivity. Ago-Sil offers excellent electrical resistance. As well, it has excellent resistance to and compatibility with most chemicals. Ago-Sil is very flexible with excellent drapability and offers a wide versatility of use in industry with a service temperature to 2000° F. Applications include drop curtains for 'hot work' such as welding and burning, thermal and electrical insulation, stress relieving and curtains in front of furnace and oven openings. A host of miscellaneous jobs such as tray covers, pipe lagging, belting and sleeves, etc., can be handled by this high temperature cloth.

### Fabrication

Blankets can be fabricated to any size with stitched seams and hems on all four sides, using high temperature aramid thread. Optional brass grommets can be installed on custom blankets if required.

### Sizes

Blankets can be ordered to any size. Specify fabric #, height x width (and grommet location if required) when ordering. Standard blanket sizes are listed below with their respective item numbers.

### Pricing

Custom Blankets ..... \$ 11.15 per square foot

### Standard Blanket Sizes

Item #	Height	Width	Price
FB-035-0303	3'	3'	\$ 100.35
FB-035-0304	3'	4'	\$ 133.80
FB-035-0305	3'	5'	\$ 167.25
FB-035-0306	3'	6'	\$ 200.70
FB-035-0307	3'	7'	\$ 234.15
FB-035-0308	3'	8'	\$ 267.60
FB-035-0309	3'	9'	\$ 301.05
FB-035-0310	3'	10'	\$ 334.50
FB-035-0311	3'	11'	\$ 367.95
FB-035-0312	3'	12'	\$ 401.40

Item #	Height	Width	Price
FB-035-0603	6'	3'	\$ 200.70
FB-035-0604	6'	4'	\$ 267.60
FB-035-0605	6'	5'	\$ 334.50
FB-035-0606	6'	6'	\$ 401.40
FB-035-0607	6'	7'	\$ 468.30
FB-035-0608	6'	8'	\$ 535.20
FB-035-0609	6'	9'	\$ 602.10
FB-035-0610	6'	10'	\$ 669.00
FB-035-0611	6'	11'	\$ 735.90
FB-035-0612	6'	12'	\$ 802.80



**INDUSTRIES INC.**

PO Box 7132  
London, Ontario  
N5Y 4J9

Tel: (519) 452-3780  
Fax: (519) 452-3053

# Safety Curtains

## Aluminized Aramid

See Fabric # 038

### Description

This fabric is made from a blend of Aramid and Glass fibres. A vacuum metallized dual mirror finished aluminized Mylar film is bonded to one side of the fabric. This fabric is intended for radiant heat reflectivity and will withstand molten metal splash to 3000° F. The mylared aluminium fabric does not delaminate and is very soft and flexible. This fabric is intended for radiant heat and molten metal splash curtains and apparel.

### Fabrication

Curtains can be fabricated to any size with stitched seams and hems on all four sides using high temperature aramid thread. Optional brass grommets can be installed on curtains if required.

### Sizes

Curtains can be ordered to any size. Specify fabric #, height x width (and grommet location if required) when ordering.

### Pricing

Custom Curtains with grommets on top only ..... \$ 15.75 per square foot  
Custom Curtains with grommets on four sides ..... \$ 15.95 per square foot

## Aluminized Aramid/Carbon

See Fabric # 039

### Description

This fabric is made from a blend of Aramid and Carbon fibres. A vacuum metallized dual mirror finished aluminized Mylar film is bonded to one side of the fabric. This fabric is intended for radiant heat reflectivity and will withstand molten metal splash to 3000° F. The mylared aluminium fabric does not delaminate and is very soft and flexible. This fabric is intended for radiant heat and molten metal splash curtains and apparel.

### Fabrication

Curtains can be fabricated to any size with stitched seams and hems on all four sides using high temperature aramid thread. Optional brass grommets can be installed on curtains if required.

### Sizes

Curtains can be ordered to any size. Specify fabric #, height x width (and grommet location if required) when ordering.

### Pricing

Custom Curtains with grommets on top only ..... \$ 17.00 per square foot  
Custom Curtains with grommets on four sides ..... \$ 17.20 per square foot

# EMERGENCY FIRE BLANKETS

6' x 5' Agotex # 600 (see fabric # 024) fibreglass blanket comes fan-folded into a Hi-Vis vinyl pouch ready for wall mounting.

## Easy To Use:

1. Remove fire blanket from pouch by pulling downward on the exposed tab with a firm deliberate motion.
2. Open blanket to full size by quickly flipping the folded blanket
3. Drape the blanket over the flaming object in such a manner as to seal off the air and smother the fire.

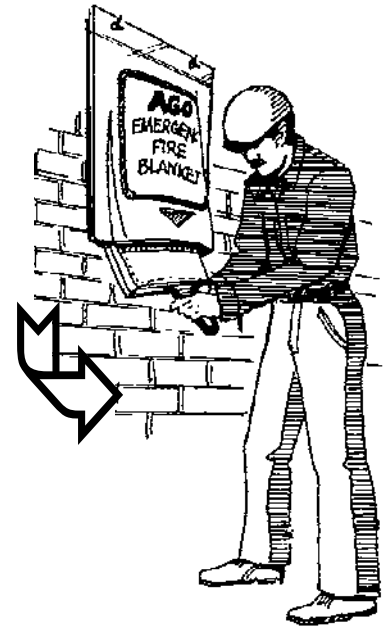

**AGO**

INDUSTRIES INC.

PO Box 7132 • London, Canada N5Y 4J9 • Tel: (519) 452-3780 • Fax: (519) 452-3053



**INDUSTRIES INC.**

PO Box 7132  
London, Ontario  
N5Y 4J9

Tel: (519) 452-3780  
Fax: (519) 452-3053

# Wall Mount Emergency Fire Blankets

Agotex #600

See Fabric # 024

## Description

This Ago Emergency Fire Blanket is fabricated from Agotex # 600 - 18oz glass cloth. It is flexible and it will conform to the contour of the object being covered, so that a total smothering effect can be obtained. This fabric will withstand temperatures to 1000° F. The blanket is packaged in a specially designed "Quick Release" wall mount pouch. The pouch is fabricated from a heavy vinyl coated nylon in a safety yellow colour denoting the contents. The pouch opening is by means of hook and loop fastener that allows quick and easy removal of the blanket in one motion. Two grommets are installed to allow the pouch to be hung on the wall.

## Pricing

SP-032	5' x 6' Agotex # 600, with Wall Pouch .....	\$129.90
SP-000	Pouch Only.....	\$ 15.75

Note: This blanket is intended to be used as an Emergency Fire Blanket to smother flames. It is resistant to sparks and light splatter from welding operations, however, fabrics #17 through #35 are more suited for medium to heavy duty welding blankets.

---

# MIG AND TIG

---

# CABLE COVER

---

**Fabricated from flame resistant 19oz neoprene coated nylon with continuous hook and loop fastener.**

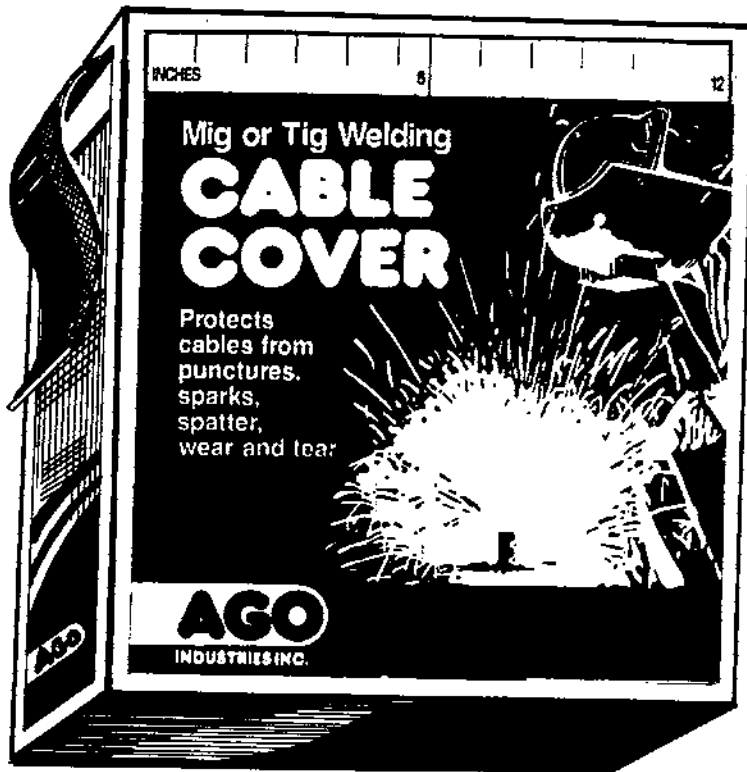

## Highly resistant to:

- ABRASION
- PUNCTURES
- SPARKS
- SPATTER
- WEAR AND TEAR

## Sizes:

CG-008-TIG 4.25" wide

CG-008-MIG 5.25' wide

Other sizes available upon request

Packed in 100' dispenser box, cable cover can be cut to any length.

---

**AGO**

INDUSTRIES INC.

PO Box 7132 • London, Canada N5Y 4J9 • Tel: (519) 452-3780 • Fax: (519) 452-3053



**INDUSTRIES INC.**

PO Box 7132  
London, Ontario  
N5Y 4J9

Tel: (519) 452-3780  
Fax: (519) 452-3053

# Welding Cable Cover

# CG-008 MIG-TIG

See Fabric # 047

## Description

AGO # CG-008 Welding Cable Cover is inexpensive protection for costly feed and power cables. The 19 oz. neoprene coated nylon fabric is highly resistant to abrasion, tearing and puncture. This flame resistant ambient temperature material allows most welding sparks to fall or bounce off preventing burn-through. The continual Hook & Loop fabric fastener provides a complete sealing of the cover that tends to eliminate snagging of the cable when passing over protruding objects and allows a dust and a dirt-free inside environment for the cables. There is no zipper to be welded closed by weld slag or dirt, and no snaps to allow snagging on protruding objects over which the cable is pulled. When cable repairs are necessary the Hook & Loop closure allows a Quick-Sure opening and may be used again either in its full or partial lengths. CG-008 Cable Cover comes conveniently packed in a Pull-Thru dispensing box that contains 100 Lineal Feet of cover, either MIG or TIG. A measuring scale is printed on the box that allows the required length of cover to be pulled out of the box and the box has a chart on which to record the remaining length of cover within the box. The box provides good storage and control of the Cable Cover.

## Pricing

<u>Standard Sizes</u>	<u>100' Roll</u>	<u>Per Foot</u>
# CG-008-MIG 5.25" Wide	\$ 365.00	\$ 3.65
# CG-008-TIG 4.25" Wide	\$ 365.00	\$ 3.65

<u>Non-Standard Special Sizes</u>	<u>100' Roll</u>	<u>Per Foot</u>
# CG-008-6      6" Wide	\$ 405.00	\$ 4.05
# CG-008-8      8" Wide	\$ 485.00	\$ 4.85
# CG-008-10    10" Wide	\$ 565.00	\$ 5.65
# CG-008-12    12" Wide	\$ 640.00	\$ 6.40

Note: Other Special Sizes are available upon request.

## Track & Hardware Installation



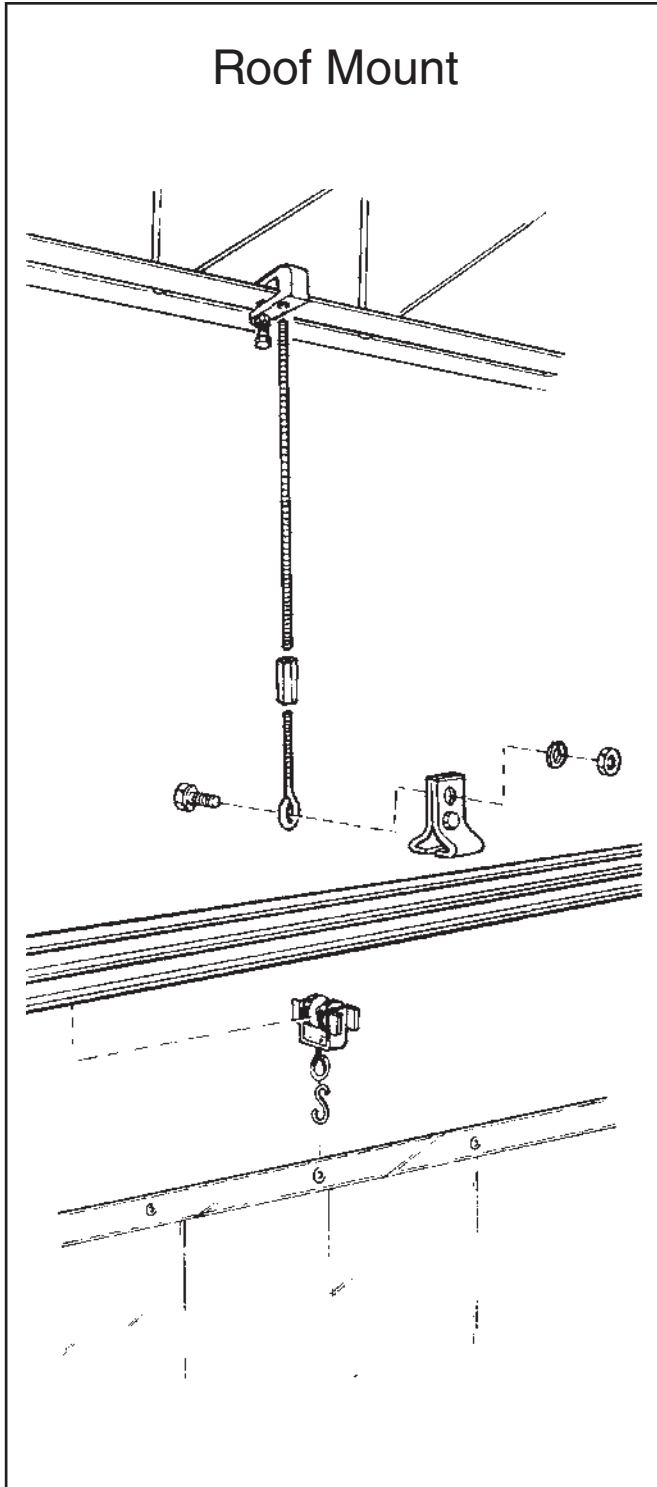

### Roof Mount

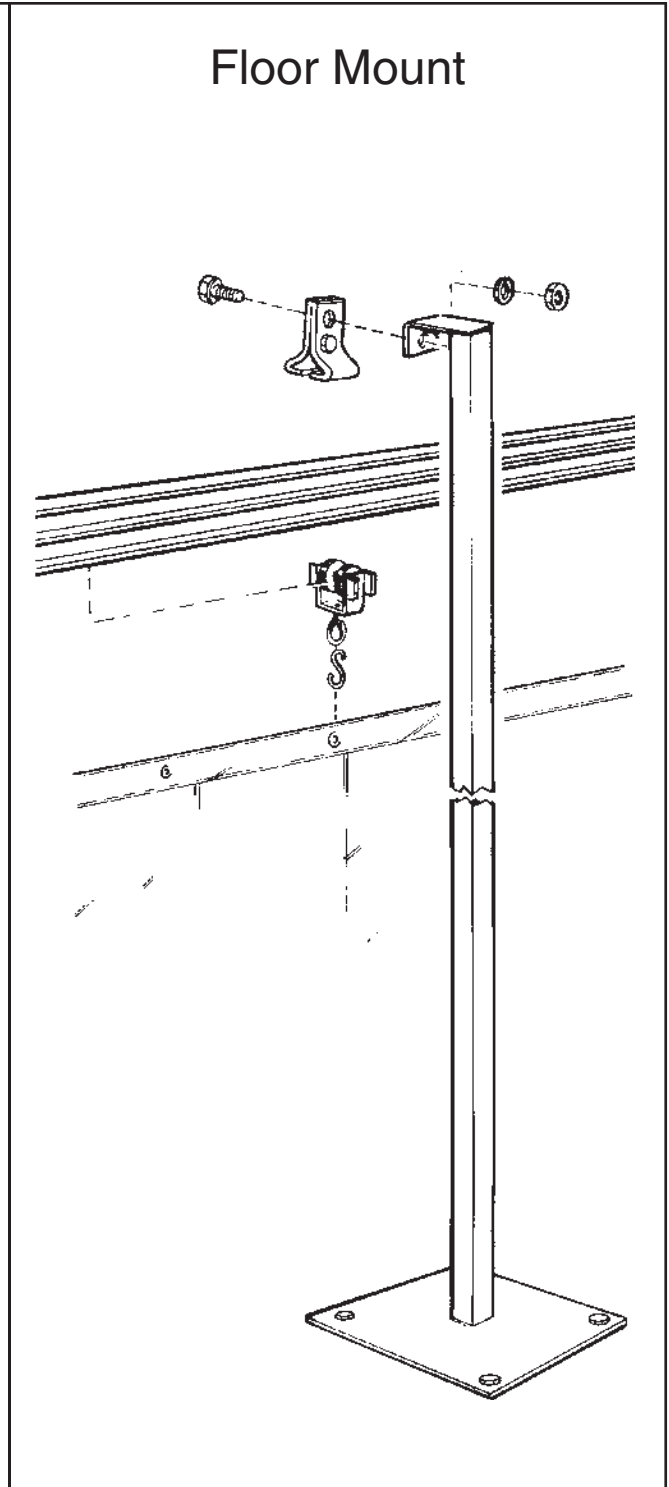

### Floor Mount

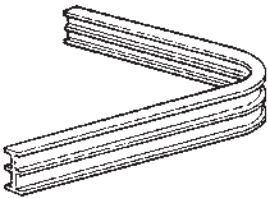
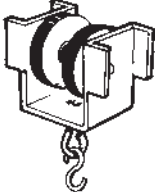
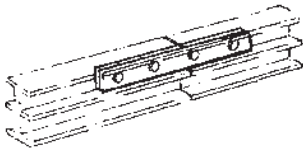
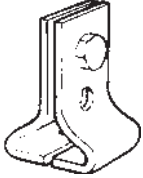
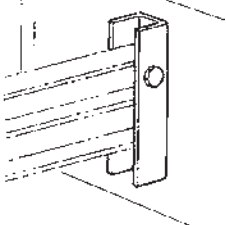
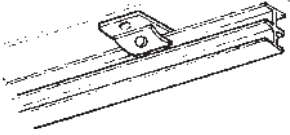
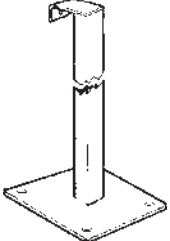

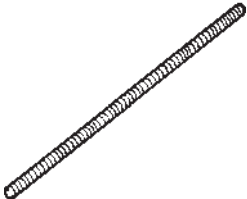
## Track & Hardware

<p><b>Channel Track</b> # CG-100</p>  <p>Heavy Duty .125 aluminium channel track. 1" wide x 2 1/2" high.</p>	<p><b>90° Curve</b> # CG-101</p>  <p>Heavy duty .125 aluminium channel curved at 90°. Attaches to straight lengths of track for continuous curtain movement.</p>	<p><b>Roller Carrier</b> # CG-102</p>  <p>Nylon wheels riveted to steel housing with swivel 'S' hook for attaching curtain.</p>	<p><b>Track Splicer</b> # CG-104</p>  <p>Heavy duty steel bracket for aligning and joining track sections.</p>
<p><b>Hanger Clamp</b> # CG-106</p>  <p>Steel hanger adjusts to any position and allows proper movement of carrier.</p>	<p><b>Wall Bracket</b> # CG-107</p>  <p>Plated steel wall bracket bolts channel track to wall.</p>	<p><b>Ceiling Mount</b> # CG-108</p>  <p>Allows a flush mount against ceiling and allows proper movement of carrier.</p>	<p><b>Standard</b> # CG-110</p>  <p>2" x 2" steel tubing to specified height with bracket to accept hanger and base plate for bolting to floor.</p>
<p><b>Beam Clamp</b> # CG-112</p>  <p>Steel 'C' Clamp attaches to overhead beam and accepts threaded rod for suspending track at required height.</p>	<p><b>Threaded Rod</b> # CG-114</p>  <p>3/8" continuous threaded rod for dropping channel track to required height.</p>	<p><b>Coupler</b> # CG-116</p>  <p>3/8" close coupling for joining threaded rod to eye rod.</p>	<p><b>Eye Rod</b> # CG-118</p>  <p>3/8" steel eye rod for joining threading rod to hanger bracket.</p>





**INDUSTRIES INC.**

PO Box 7132  
London, Ontario  
N5Y 4J9

Tel: (519) 452-3780  
Fax: (519) 452-3053

2025

- 56 -

# Track & Hardware Pricing

Item #	Description	Price
CG-100	Channel Track	\$ 11.80 / foot
CG-101	90° Curve	\$ 47.25 / each
CG-102	Roller Carrier with 'S' Hook	\$ 18.35 / each
CG-104	Track Splicer	\$ 15.75 / each
CG-106	Hanger Clamp	\$ 6.55 / each
CG-107	Wall Bracket	\$ 26.25 / each
CG-108	Ceiling Mount	\$ 19.65 / each
CG-110	Steel Standard (specify height)	\$262.50 / each
CG-112	Beam Clamp	\$ 5.55 / each
CG-114	Threaded Rod	\$ 1.30 / foot
CG-116	Coupler	\$ 1.60 / each
CG-118	Eye Rod	\$ 4.25 / each

(Drawings on pages 54 and 55)

# SAFETY/WELDING STRIP CURTAINS

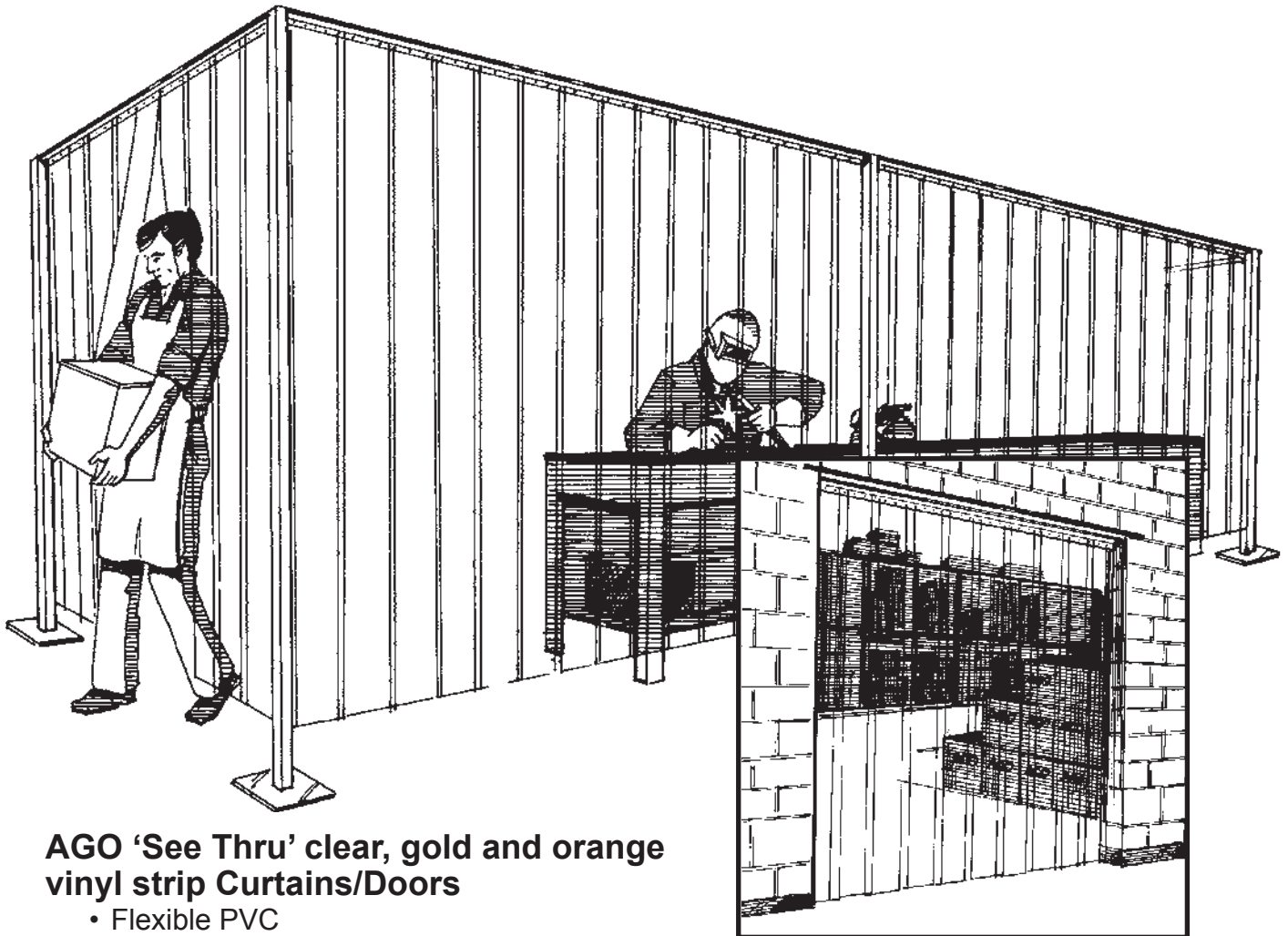

## AGO 'See Thru' clear, gold and orange vinyl strip Curtains/Doors

- Flexible PVC
- Flame Resistant

## Gold and Orange Vinyl Strip

- Used For:
- Welding Screens and booths
  - Machine enclosures
  - Grinding Shields

Unlimited access through the overlapping strip.  
As well as 'See Thru' visibility.

## Clear Vinyl Strip

Used For:

- Traffic Doors
- Dock and Entry Openings
- Draft Curtains and Doors
- Sound Attenuation Curtains
- Barrier Curtains
- Spray Booths
- Crane Ways
- Freezer Doors

**AGO**

**INDUSTRIES INC.**

PO Box 7132 • London, Canada N5Y 4J9 • Tel: (519) 452-3780 • Fax: (519) 452-3053



**INDUSTRIES INC.**

PO Box 7132  
London, Ontario  
N5Y 4J9

Tel: (519) 452-3780  
Fax: (519) 452-3053

# Safety/Welding Strip Curtains

## 80 mil Gold Weld Strip/Sheeting

See Fabric # 043

### Complete Gold Weld Strip Curtains/Doors

<u>Item #</u>	<u>Description</u>
VS-222-G	8" x .080 mil Gold 'See Thru' vinyl weld strip curtain/door with 2" overlap and complete with 2" x 2" x 3/16" angle iron mounting plate with appropriate fasteners on 2" centers.

Price ..... \$ 7.55 per square foot

- Note:*
- Specify height x width when ordering.
  - Customer must mount supplied angle.
  - Alternative 1/4" flat bar mounting plate available, specify.
  - Optional floor mount standards or roof mount threaded rods available, see page 54 for optional hardware.

### Replacement Gold Weld Strips

<u>Item #</u>	<u>Description</u>
VR-220-G	8" x .080 mil Gold 'See Thru' vinyl replacement strips, cut to length and punched on 2" centers on top side, ready for mounting.

Price ..... \$ 3.00 per lineal foot

- Note:*
- Specify length of strips when ordering.
  - 2" overlap recommended, therefore, 2 strips are required per foot of width.

### 48" Wide Gold Weld Sheeting

<u>Item #</u>	<u>Description</u>
VR-520-G	48" x .080 mil Gold 'See Thru' vinyl weld sheet, supplied to any length. Ready to hang in sheet form.

Price ..... \$ 6.00 per square foot

- Note:*
- Sheets can be ordered in 48" wide strip form, specify length when ordering.
  - Sheeting can also be sewn in curtain form, with eyelets on four sides on 12" centers, specify height x width when ordering.
  - Sheeting can be supplied with grommets on top for hanging by hooks, specify when ordering.



**INDUSTRIES INC.**

PO Box 7132  
London, Ontario  
N5Y 4J9

Tel: (519) 452-3780  
Fax: (519) 452-3053

# Safety/Welding Strip Curtains

## 80 mil Orange Weld Strip/Sheeting

See Fabric # 042

### Complete Orange Weld Strip Curtains/Doors

<u>Item #</u>	<u>Description</u>
VS-222-O	8" x .080 mil Orange 'See Thru' vinyl weld strip curtain/door with 2" overlap and complete with 2" x 2" x 3/16" angle iron mounting plate with appropriate fasteners on 2" centers.
	Price ..... \$ 7.55 per square foot
<i>Note:</i>	<ul style="list-style-type: none"> <li>• Specify height x width when ordering.</li> <li>• Customer must mount supplied angle.</li> <li>• Alternate 1/4" flat bar mount in place of angle.</li> <li>• Optional floor mount or roof mount standards and threaded rods available. See page 54 for optional hardware.</li> </ul>

### Replacement Orange Weld Strips

<u>Item #</u>	<u>Description</u>
VR-220-O	8" x .080 mil Orange 'See Thru' vinyl replacement strips, cut to length and punched on 2" centers on top side, ready for mounting.
	Price ..... \$ 3.00 per lineal foot
<i>Note:</i>	<ul style="list-style-type: none"> <li>• Specify length of strips when ordering.</li> <li>• 2" overlap recommended, therefore, 2 strips are required per foot of width.</li> </ul>



**INDUSTRIES INC.**

PO Box 7132  
London, Ontario  
N5Y 4J9

Tel: (519) 452-3780  
Fax: (519) 452-3053

# Safety Strip Curtains/Doors

## Clear Strip Curtain/Doors

See Fabric # 040, 041, 045, 046

<u>Item #</u>	<u>Description</u>	
VS-112-C	6" x 60 mil	Clear vinyl strip Curtain/Door with 2" overlap and angle mount. Specify height x width when ordering. Price ..... \$ 6.20 per square foot
VS-222-C	8" x 80 mil	Clear vinyl strip Curtain/Door with 2" overlap and angle mount. Specify height x width when ordering. Price ..... \$ 7.00 per square foot
VS-224-C	8" x 80 mil	Clear vinyl strip Curtain/Door with 4" overlap and angle mount. Specify height x width when ordering. Price ..... \$ 8.40 per square foot
VS-324-C	12" x 80 mil	Clear vinyl strip Curtain/Door with 4" overlap and angle mount. Specify height x width when ordering. Price ..... \$ 8.20 per square foot
VS-326-C	12" x 80 mil	Clear vinyl strip Curtain/Door with 6" overlap and angle mount. Specify height x width when ordering. Price ..... \$ 9.50 per square foot
VS-334-C	12" x 120 mil	Clear vinyl strip Curtain/Door with 4" overlap and angle mount. Specify height x width when ordering. Price ..... \$ 9.15 per square foot
VS-336-C	12" x 120 mil	Clear vinyl strip Curtain/Door with 6" overlap and angle mount. Specify height x width when ordering. Price ..... \$ 10.50 per square foot
VS-446-C	16" x 160 mil	Clear vinyl strip Curtain/Door with 6" overlap and angle mount. Specify height x width when ordering. Price ..... \$ 12.10 per square foot
VS-448-C	16" x 160 mil	Clear vinyl strip Curtain/Door with 8" overlap and angle mount. Specify height x width when ordering. Price ..... \$ 15.10 per square foot



**INDUSTRIES INC.**

PO Box 7132  
London, Ontario  
N5Y 4J9

Tel: (519) 452-3780  
Fax: (519) 452-3053

# Clear Replacement Strips

## Clear PVC Replacement Strips

See Fabric # 040, 041, 045, 046

<u>Item #</u>	<u>Description</u>	
VR-110-C	6" x 60 mil	Clear vinyl replacement strips, punched on 2" centers on top sides. Specify length when ordering. Price ..... \$ 1.95 per lineal foot
VR-220-C	8" x 80 mil	Clear vinyl replacement strips, punched on 2" centers on top sides. Specify length when ordering. Price ..... \$ 2.75 per lineal foot
VR-320-C	12" x 80 mil	Clear vinyl replacement strips, punched on 2" centers on top sides. Specify length when ordering. Price ..... \$ 4.10 per lineal foot
VR-330-C	12" x 120 mil	Clear vinyl replacement strips, punched on 2" centers on top sides. Specify length when ordering. Price ..... \$ 5.90 per lineal foot
VR-440-C	16" x 160 mil	Clear vinyl replacement strips, punched on 2" centers on top sides. Specify length when ordering. Price ..... \$ 10.15 per lineal foot
VR-520-C	48" x 80 mil	Clear vinyl sheeting, supplied as requested. Price ..... \$ 5.65 per square foot
VR-530-C	48" x 120 mil	Clear vinyl sheeting, supplied as requested. Price ..... \$ 8.20 per square foot
VR-540-C	48" x 160 mil	Clear vinyl sheeting, supplied as requested. Price ..... \$10.80 per square foot



**INDUSTRIES INC.**

PO Box 7132  
London, Ontario  
N5Y 4J9

Tel: (519) 452-3780  
Fax: (519) 452-3053

# Safety/Welding Strip Curtains

## 80 mil Black 'Opaque' Strip

See Fabric # 044

### Complete Black - Non 'See Thru' Strip Curtain/Doors

<u>Item #</u>	<u>Description</u>
VS-222-B	8" x .080 mil Black 'Opaque' vinyl strip curtain/door with 2" overlap and complete with 2" x 2" x 3/16" angle iron mounting plate with appropriate fasteners on 2" centers.

Price ..... \$ 8.85 per square foot

- Note:*
- Specify height x width when ordering.
  - Alternate 1/4" flat bar mount in place of angle.
  - Customer must mount supplied angle.
  - Optional floor mount or roof mount standards and threaded rods available. See page 54 for optional hardware.

### Replacement Black - Non 'See Thru' Strips

<u>Item #</u>	<u>Description</u>
VR-220-B	8" x .080 mil Black 'Opaque' vinyl replacement strips, cut to length and punched on 2" centers on top side, ready for mounting.

Price ..... \$ 3.65 per lineal foot

- Note:*
- Specify length of strips when ordering.
  - 2" overlap recommended, therefore, 2 strips are required per foot of width.

---

**The hand is Man's most important tool! Cover them with...**

---

# **HIGH TEMPERATURE PROTECTIVE MITTS & GLOVES**

---



**Industrial use high temperature hand covering with superior thermal, chemical and abrasion resistant qualities.**

- Fabrics Used:**
- Fibreglass Cloth
  - Kevlar® Cloth
  - Aluminized Cloth

**AGO**

**INDUSTRIES INC.**

PO Box 7132 • London, Canada N5Y 4J9 • Tel: (519) 452-3780 • Fax: (519) 452-3053





**INDUSTRIES INC.**

PO Box 7132  
London, Ontario  
N5Y 4J9

Tel: (519) 452-3780  
Fax: (519) 452-3053

# High Temperature Mitts & Gloves

## Agotex Fibreglass Cloth

See Fabric # 027

Item #	Description	Price/Pair
MG-A00	Mitts 14" single palm reversible	\$ 43.30
MG-A01	Mitts 14" double palm reversible	\$ 63.00
MG-A02	Mitts 14" double palm reversible with aluminized back	\$ 72.15
MG-A03	Overmitts 9" reversible protection for mitts	\$ 23.60
MG-A04	Gloves 14" standard 5 finger	\$ 63.00
MG-A05	Gloves 14" aluminized back, 5 finger	\$ 72.15

(Mitts and Gloves lined with 11 oz. wool)

## Aramid Cloth

See Fabric # 019

Item #	Description	Price/Pair
MG-K00	Mitts 14" single palm reversible	\$ 57.75
MG-K01	Mitts 14" double palm reversible	\$ 76.10
MG-K02	Mitts 14" double palm reversible with aluminized back	\$ 84.00
MG-K03	Overmitts 9" reversible protection for mitts	\$ 28.85
MG-K04	Gloves 14" standard 5 finger	\$ 76.10
MG-K05	Gloves 14" aluminized back 5 finger	\$ 84.00

(Mitts and Gloves lined with 11 oz. wool)

## Aramid Knit Cloth

Item #	Description	Price/Pair
SP-106	18" 2 ply Kevlar Knit Sleeve, with thumbhole	\$ 21.65

## Aluminized Hand Heat Reflectors

Item #	Description	Price/Pair
AL-913	Reflectors 5" x 7" with elastic straps	\$ 13.10

---

# FLAME RESISTANT CLOTHING

---

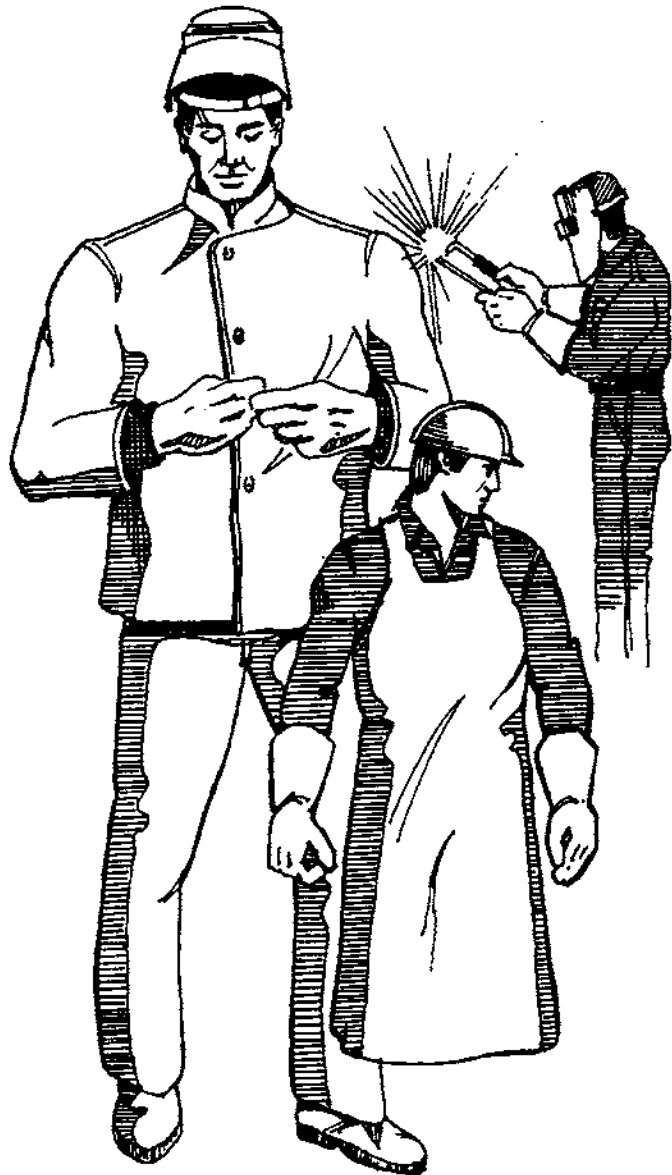

**Complete  
protection from  
head to toe:**

- WELDERS JACKETS  
AND PANTS
- SHOP COATS
- COVERALLS
- APRONS
- SLEEVES
- LEGGINGS
- ALUMINIZED  
GARMENTS
- SPECIALITY ITEMS

COMPLETE CUSTOM FLAME RESISTANT  
CLOTHING TO ANY REQUIRED SPECIFICATION

**AGO**

INDUSTRIES INC.

PO Box 7132 • London, Canada N5Y 4J9 • Tel: (519) 452-3780 • Fax: (519) 452-3053

# Protective Clothing

## Flame Resistant 100% Cotton

### Green 9oz FR-7A<sup>®</sup> Sateen

### Navy 9oz INDURA<sup>®</sup> Sateen

See Fabric # 048

# KG-110-GRN # KG-110-NAV	1/2 Jacket	18" length with snap closures (cape sleeve) <ul style="list-style-type: none"><li>• Sizes: S, M, L, XL, 2XL, 3XL</li><li>• Colour: Green (GRN) or Navy (NAV)</li></ul>
# KG-114-GRN # KG-114-NAV	Jacket	30" length with snap closure and inside pocket <ul style="list-style-type: none"><li>• Sizes: S, M, L, XL, 2XL, 3XL</li><li>• Colour: Green (GRN) or Navy (NAV)</li></ul>
# KG-117-NAV	Shop Coat	Snap closure with action back and 3 pockets <ul style="list-style-type: none"><li>• Sizes: S, M, L, XL, 2XL, 3XL</li><li>• Colour: Navy (NAV)</li></ul>
# KG-130-NAV	Coverall	Snap and zipper closure, action back and all pockets <ul style="list-style-type: none"><li>• Sizes: Chests 36, 38, 40, 42, 44, 46, 48, 50, 52, 54, 56, 58, 60</li><li>• Colour: Navy (NAV)</li></ul>
# KG-150-GRN # KG-150-NAV	Apron	Bib Style, 24" x 36" with waist and neck ties <ul style="list-style-type: none"><li>• Colour: Green (GRN) or Navy (NAV)</li></ul>
# KG-160-GRN # KG-160-NAV	Sleeves	18" length with snaps at wrist and velcro top closure <ul style="list-style-type: none"><li>• Colour: Green (GRN) or Navy (NAV)</li></ul>
# KG-162-GRN # KG-162-NAV	Sleeves	18" length with elastic top & bottom <ul style="list-style-type: none"><li>• Colour: Green (GRN) or Navy (NAV)</li></ul>
# KG-165-GRN # KG-165-NAV	Sleeves	24" length with snaps at wrist and adjustable shoulder strap <ul style="list-style-type: none"><li>• Colour: Green (GRN) or Navy (NAV) (pairs)</li></ul>
# KG-170-NAV	Arab Hat	Welders skull cap with neck protector, flap on back <ul style="list-style-type: none"><li>• Colour: Navy (NAV)</li></ul>
#KG-172-GRN #KG-172-NAV	Spatter Hood	Completely covers head and neck - hook & loop closure <ul style="list-style-type: none"><li>• Colour: Green (GRN) or Navy (NAV)</li></ul>
# KG-175-NAV	Helmet Bib	Bib velcros onto front of welding helmet and protects front of neck <ul style="list-style-type: none"><li>• Colour: Navy (NAV)</li></ul>

(Pricing on Page 67)



**INDUSTRIES INC.**

PO Box 7132  
London, Ontario  
N5Y 4J9

Tel: (519) 452-3780  
Fax: (519) 452-3053

# Protective Clothing Flame Resistant 100% Cotton

Green 9oz FR-7A<sup>®</sup> Sateen

Navy 9oz INDURA<sup>®</sup> Sateen

See Fabric # 048

Item #	Description	Price
KG-110	1/2 Jacket	\$ 47.25
KG-114	Jacket	\$ 55.10
KG-117	Shop Coat	\$ 85.30
KG-130	Coverall	\$124.65
KG-150	Bib Apron	\$ 18.35
KG-160	Sleeves (pair)	\$ 18.35
KG-162	Sleeves (pair)	\$ 18.35
KG-165	Sleeves (pair)	\$ 23.60
KG-170	Arab Hat	\$ 7.55
KG-172	Spatter Hood	\$ 26.25
KG-175	Helmet Bib	\$ 13.75

(Description on Page 66)

### Oversize charges

Jacket Sizes XL, 2XL and 3XL    add 10%  
Jacket Sizes 4XL and up        add 20%

Coverall Chest sizes 48 to 56    add 10%  
Coverall Chest sizes 58 & up    add 20%



**INDUSTRIES INC.**

PO Box 7132  
London, Ontario  
N5Y 4J9

Tel: (519) 452-3780  
Fax: (519) 452-3053

# Protective Clothing Flame Resistant 100% Cotton

## 13oz INDURA® Whipcord

See Fabric # 049

# KG-214-GRN	Jacket	30" length with snap closure and inside pocket
# KG-214-NAV		<ul style="list-style-type: none"><li>• Sizes: S, M, L, XL, 2XL, 3XL</li><li>• Colour: Green (GRN) or Navy (NAV)</li></ul>
# KG-250-GRN	Apron	Bib Style, 24" x 36" with waist and neck ties
# KG-250-NAV		<ul style="list-style-type: none"><li>• Colour: Green (GRN) or Navy (NAV)</li></ul>
# KG-260-GRN	Sleeves	18" length with snaps at wrist and velcro top closure
# KG-260-NAV		<ul style="list-style-type: none"><li>• Colour: Green (GRN) or Navy (NAV)</li></ul>
# KG-265-GRN	Sleeves	24" length with snaps at wrist and adjustable shoulder strap
# KG-265-NAV		<ul style="list-style-type: none"><li>• Colour: Green (GRN) or Navy (NAV)</li></ul>

\* Pricing on Page 69 \*



**INDUSTRIES INC.**

PO Box 7132  
London, Ontario  
N5Y 4J9

Tel: (519) 452-3780  
Fax: (519) 452-3053

# Protective Clothing Flame Resistant 100% Cotton

## 13oz INDURA® Whipcord

See Fabric # 049

Item #	Description	Price
KG-214	Jacket	\$ 68.25
KG-250	Bib Apron	\$ 23.60
KG-260	Sleeves (pair)	\$ 23.60
KG-265	Sleeves (pair)	\$ 28.85

(Description on Page 68)

### Oversize charges

Jacket Sizes XL, 2XL and 3XL	add 10%
Jacket Sizes 4XL and up	add 20%



**INDUSTRIES INC.**

PO Box 7132  
London, Ontario  
N5Y 4J9

Tel: (519) 452-3780  
Fax: (519) 452-3053

# Aluminized Garments

## Aluminized Rayon

See Fabric # 036

### Description

The base fabric is PFR Rayon. A vacuum metallized dual mirror finished aluminized mylar film is bonded to one side. This fabric is intended for reflecting radiant heat. Not recommended for molten metal splash.

Item #	Style	Description	Price
AL-605	Jacket	30" length with snap closure and inside pocket • Sizes: S, M, L, XL, 2XL, 3XL • Sizes XL and up add 10% to price	\$ 393.75
AL-610	Coat	50" length with snap closures and inside pocket • Sizes: S, M, L, XL, 2XL, 3XL • Sizes XL and up add 10% to price	\$ 492.15
AL-620	Pant	Waist style with zippered fly, belt loops, suspenders and back pockets • Sizes: S, M, L, XL, 2XL, 3XL • Sizes XL and up add 10% to price	\$ 393.75
AL-640	Apron	Bib Style, 24" x 36" with Heavy Duty Straps and Quick Clip Buckles	\$ 124.65
AL-650	Sleeves	18" length with snaps at wrist and velcro top closure	\$ 105.00
AL-655	Sleeves	24" length with snaps at wrist and adjustable shoulder strap	\$ 131.25
AL-660	Spats	12" high with velcro closure and mouldable toe cover	\$ 157.50
Aluminized Hoods		Complete head encapsulation (hard hat included)	
AL-670-C	Hood	With Clear Acrylic Lens	\$ 360.90
AL-670-G	Hood	With Green tint Acrylic Lens	\$ 360.90
AL-670-GLD	Hood	With High Heat Gold Reflective Lens	\$ 525.00
AL-670-GRN/GLD	Hood	With High Heat Green/Gold Lens	\$ 525.00



**INDUSTRIES INC.**

PO Box 7132  
London, Ontario  
N5Y 4J9

Tel: (519) 452-3780  
Fax: (519) 452-3053

# Aluminized Garments

## Aluminized Preox®

See Fabric # 037

### Description

The base fabric is Preox® Carbon. A vacuum metallized dual mirror finished aluminized mylar film is bonded to one side. This fabric is intended for reflecting radiant heat and shedding molten metal splash up to 3000° F.

Item #	Style	Description	Price
AL-805	Jacket	30" length with snap closure and inside pocket • Sizes: S, M, L, XL, 2XL, 3XL • Sizes XL and up add 10% to price	\$ 492.15
AL-810	Coat	50" length with snap closures and inside pocket • Sizes: S, M, L, XL, 2XL, 3XL • Sizes XL and up add 10% to price	\$ 649.55
AL-820	Pant	Waist style with zippered fly, belt loops, suspenders and back pockets • Sizes: S, M, L, XL, 2XL, 3XL • Sizes XL and up add 10% to price	\$ 492.15
AL-840	Apron	Bib Style, 24" x 36" with Heavy Duty Straps and Quick Clip Buckles	\$ 157.50
AL-850	Sleeves	18" length with snaps at wrist and velcro top closure	\$ 131.25
AL-855	Sleeves	24" length with snaps at wrist and adjustable shoulder strap	\$ 177.15
AL-860	Spats	12" high with velcro closure and mouldable toe cover	\$ 196.85
Aluminized Hoods		Complete head encapsulation (hard hat included)	
AL-870-C	Hood	With Clear Acrylic Lens	\$ 393.75
AL-870-G	Hood	With Green tint Acrylic Lens	\$ 393.75
AL-870-GLD	Hood	With High Heat Gold Reflective Lens	\$ 590.60
AL-870-GRN/GLD	Hood	With High Heat Green/Gold Lens	\$ 590.60





**INDUSTRIES INC.**

PO Box 7132  
London, Ontario  
N5Y 4J9

Tel: (519) 452-3780  
Fax: (519) 452-3053

# Aluminized Garments

## Aluminized Aramid

See Fabric # 038

### Description

The base fabric is an Aramid/Glass blend. A vacuum metallized dual mirror finished aluminized mylar film is bonded to one side. This fabric is intended for reflecting radiant heat and shedding molten metal splash up to 3000° F.

Item #	Style	Description	Price
AL-505	Jacket	30" length with snap closure and inside pocket • Sizes: S, M, L, XL, 2XL, 3XL • Sizes XL and up add 10% to price	\$ 433.10
AL-510	Coat	50" length with snap closures and inside pocket • Sizes: S, M, L, XL, 2XL, 3XL • Sizes XL and up add 10% to price	\$ 557.80
AL-520	Pant	Waist style with zippered fly, belt loops, suspenders and back pockets • Sizes: S, M, L, XL, 2XL, 3XL • Sizes XL and up add 10% to price	\$ 433.10
AL-540	Apron	Bib Style, 24" x 36" with Heavy Duty Straps and Quick Clip Buckles	\$ 137.80
AL-550	Sleeves	18" length with snaps at wrist and velcro top closure	\$ 118.10
AL-555	Sleeves	24" length with snaps at wrist and adjustable shoulder strap	\$ 150.90
AL-560	Spats	12" high with velcro closure and mouldable toe cover	\$ 177.15
Aluminized Hoods		Complete head encapsulation (hard hat included)	
AL-570-C	Hood	With Clear Acrylic Lens	\$ 374.05
AL-570-G	Hood	With Green tint Acrylic Lens	\$ 374.05
AL-570-GLD	Hood	With High Heat Gold Reflective Lens	\$ 551.25
AL-570-GRN/GLD	Hood	With High Heat Green/Gold Lens	\$ 551.25



**INDUSTRIES INC.**

PO Box 7132  
London, Ontario  
N5Y 4J9

Tel: (519) 452-3780  
Fax: (519) 452-3053

# Aluminized Garments

## Aluminized Aramid/Carbon

See Fabric # 039

### Description

The base fabric is an Aramid/Carbon blend. A vacuum metallized dual mirror finished aluminized mylar film is bonded to one side. This fabric is intended for reflecting radiant heat, and shedding molten metal splash up to 3000° F.

Item #	Style	Description	Price
AL-905	Jacket	30" length with snap closure and inside pocket • Sizes: S, M, L, XL, 2XL, 3XL • Sizes XL and up add 10% to price	\$ 492.15
AL-910	Coat	50" length with snap closures and inside pocket • Sizes: S, M, L, XL, 2XL, 3XL • Sizes XL and up add 10% to price	\$ 649.65
AL-920	Pant	Waist style with zippered fly, belt loops, suspenders and back pockets • Sizes: S, M, L, XL, 2XL, 3XL • Sizes XL and up add 10% to price	\$ 492.15
AL-940	Apron	Bib Style, 24" x 36" with Heavy Duty Straps and Quick Clip Buckles	\$ 157.50
AL-950	Sleeves	18" length with snaps at wrist and velcro top closure	\$ 131.25
AL-955	Sleeves	24" length with snaps at wrist and adjustable shoulder strap	\$ 177.15
AL-960	Spats	12" high with velcro closure and mouldable toe cover	\$ 196.85
Aluminized Hoods		Complete head encapsulation (hard hat included)	
AL-970-C	Hood	With Clear Acrylic Lens	\$ 393.75
AL-970-G	Hood	With Green tint Acrylic Lens	\$ 393.75
AL-970-GLD	Hood	With High Heat Gold Reflective Lens	\$ 590.60
AL-970-GRN/GLD	Hood	With High Heat Green/Gold Lens	\$ 590.60

PO Box 7132  
London, Ontario  
N5Y 4J9

# Roll Goods

Tel: (519) 452-3780  
Fax: (519) 452-3053

\* All our fabrics can be purchased unfabricated in roll form. Call for current price. \*

Sample #	Item #	Description	Size
001	RG-VIN-200	Yellow 'See Thru' Vinyl Weld Film	66" x 100 yards per roll
002	RG-VIN-205	Orange 'See Thru' Vinyl Weld Film	66" x 100 yards per roll
003	RG-VIN-206	Blue 'See Thru' Vinyl Weld Film	66" x 100 yards per roll
004	RG-VIN-190	Green 'See Thru' Vinyl Weld Film	66" x 100 yards per roll
005	RG-VIN-207	Shade 8 'See Thru' Vinyl Weld Film	66" x 100 yards per roll
007	RG-VIN-230	16 mil Clear 'See Thru' Vinyl Film	54" x 70 yards per roll
008	RG-VIN-240	20 mil Clear 'See Thru' Vinyl Film	54" x 55 yards per roll
009-CLR	RG-VIN-260	40 mil Clear 'See Thru' Vinyl Film	48" x 50 yards per roll
009-ORN	RG-VIN-265	40 mil Orange 'See Thru' Vinyl Film	48" x 50 yards per roll
009-GLD	RG-VIN-270	40 mil Gold 'See Thru' Vinyl Film	48" x 50 yards per roll
010	RG-600-010	10oz Flame Resistant Cotton Duck	60" x 100 yards per roll
011	RG-600-015	15oz Flame Resistant Cotton Duck	60" x 100 yards per roll
012	RG-600-017	20oz Flame Resistant Cotton Duck	60" x 100 yards per roll
013	RG-600-020	16oz Vinyl/Poly - Green	62" x 50 meters per roll
013	RG-600-025	16oz Vinyl/Poly - Yellow	62" x 50 meters per roll
013	RG-600-030	16oz Vinyl/Poly - Black	62" x 50 meters per roll
013	RG-600-032	16oz Vinyl/Poly - White	62" x 50 meters per roll
013	RG-600-033	16oz Vinyl/Poly - Grey	62" x 50 meters per roll
013	RG-600-035	16oz Vinyl/Poly - Blue	62" x 50 meters per roll
014	RG-600-040	19oz Vinyl/Poly - Green	62" x 50 meters per roll
014	RG-600-045	19oz Vinyl/Poly - Yellow	62" x 50 meters per roll
014	RG-600-050	19oz Vinyl/Poly - Black	62" x 50 meters per roll
014	RG-600-052	19oz Vinyl/Poly - White	62" x 50 meters per roll
014	RG-600-053	19oz Vinyl/Poly - Red	62" x 50 meters per roll
014	RG-600-055	19oz Vinyl/Poly - Blue	62" x 50 meters per roll
015	RG-600-110	19oz Neony	60" x 50 meters per roll
016	RG-600-115	40oz Neony	60" x 30 meters per roll
017	RG-600-135	22oz Goldengard	60" x 50 yards per roll
018	RG-600-136	30oz Goldengard	60" x 50 yards per roll
019	RG-600-070	22oz Aramid	60" x 50 yards per roll
020	RG-600-075	23oz Weldflex	60" x 50 yards per roll
021	RG-600-120	16oz Carbon Felt	60" x 100 yards per roll



**INDUSTRIES INC.**

PO Box 7132  
London, Ontario  
N5Y 4J9

Tel: (519) 452-3780  
Fax: (519) 452-3053

# Roll Goods

Sample #	Item #	Description	Size
022	RG-600-129	17oz Heatstop - Grey	60" x 50 yards per roll
023	RG-600-130	32oz Heatstop - Red	60" x 50 yards per roll
024	RG-600-139	18oz Agotex # 600	40" x 50 yards per roll
024	RG-600-140	18oz Agotex # 600 - Red	60" x 50 yards per roll
025	RG-600-145	24oz Agotex # 800	40" x 50 yards per roll
025	RG-600-146	24oz Agotex # 800 - Orange	60" x 50 yards per roll
026	RG-600-150	30oz Agotex # 1000	60" x 50 yards per roll
027	RG-600-159	35oz Agotex # 1200	60" x 50 yards per roll
028	RG-600-162	40oz Agotex # 1500	60" x 50 yards per roll
029	RG-600-163	60oz Agotex # 2000	60" x 50 yards per roll
029	RG-600-185	Agotex High Heat Tape	2" x100 feet per roll
029	RG-600-190	Agotex High Heat Tape	6" x100 feet per roll
030	RG-600-170	31oz Agotex Plus # 1000-P	60" x 50 yards per roll
032	RG-600-176	41oz Agotex Plus # 1500-P	60" x 50 yards per roll
034	RG-600-060	Ago-Sil # 1800	36" x 50 yards per roll
035	RG-600-065	Ago-Sil # 3600	36" x 50 yards per roll
036	RG-600-093	Aluminized Rayon	40" x 50 meters per roll
037	RG-600-094	Aluminized Preox®	40" x 50 meters per roll
038	RG-600-084	Aluminized Aramid	40" x100 yards per roll
039	RG-600-087	Aluminized Aramid/Carbon	40" x 50 yards per roll
040	RG-VIN-020	60 mil Clear Strip	6" x400 feet per roll
041	RG-VIN-030	80 mil Clear Strip	8" x300 feet per roll
041	RG-VIN-040	80 mil Clear Strip	12" x225 feet per roll
041	RG-VIN-150	80 mil Clear Sheeting	48" x 60 feet per roll
042	RG-VIN-188	80 mil Orange Weld Strip	8" x300 feet per roll
043	RG-VIN-185	80 mil Gold Weld Strip	8" x300 feet per roll
043	RG-VIN-180	80 mil Gold Weld Sheeting	48" x 60 feet per roll
044	RG-VIN-189	80 mil Black 'Opaque' Weld Strip	8" x300 feet per roll
045	RG-VIN-050	120 mil Clear Strip	12" x200 feet per roll
045	RG-VIN-160	120 mil Clear Sheeting	48" x 60 feet per roll
046	RG-VIN-060	160 mil Clear Strip	16" x100 feet per roll
046	RG-VIN-170	160 mil Clear Sheeting	48" x 60 feet per roll
050	RG-600-019	13oz Vinyl/Poly - Clear Translucent Reinforced	54" x100 meters per roll



**AGO** Fabric #001  
Yellow 'See Thru' Vinyl  
Information on page 15



**AGO** Fabric #002  
Orange 'See Thru' Vinyl  
Information on page 16



**AGO** Fabric #003  
Blue 'See Thru' Vinyl  
Information on page 17



**AGO** Fabric #004  
Green 'See Thru' Vinyl  
Information on page 18



**AGO**

Fabric #005

Shade 8 'See Thru' Vinyl

Information on page 19



**AGO**

Fabric #006

Combo 'See Thru' Vinyl

Information on page 20



**AGO**

Fabric #007

16 mil Clear 'See Thru' Vinyl

Information on page 21



**AGO**

Fabric #008

20 mil Clear 'See Thru' Vinyl

Information on page 22



**AGO**

Fabric #009-CLR

40 mil Clear 'See Thru' Vinyl

Information on page 23



**AGO**

Fabric #009-ORN

40 mil Orange 'See Thru' Vinyl

Information on page 24



**AGO**

Fabric #009-GLD

40 mil Gold 'See Thru' Vinyl

Information on page 25



**AGO**

Fabric #010

10oz Flame Resistant Cotton Duck

Information on page 26



**AGO**

Fabric #011

15oz Flame Resistant Cotton Duck

Information on page 27

**AGO**

Fabric #012

20oz Flame Resistant Cotton Duck

Information on page 28

**AGO**

Fabric #013

16 oz Vinyl-Poly

Information on page 29

**AGO**

Fabric #014

19oz Vinyl-Poly

Information on page 30





**AGO** Fabric #015  
19oz Neony  
Information on page 32



**AGO** Fabric #016  
40oz Neony  
Information on page 32



**AGO** Fabric #017  
22oz Goldengard  
Information on page 33



**AGO** Fabric #018  
30oz Goldengard  
Information on page 34



**AGO**

Fabric #019  
22oz Aramid  
Information on page 35



**AGO**

Fabric #020  
23oz Weldflex  
Information on page 36



**AGO**

Fabric #021  
16oz Carbon Felt  
Information on page 37



**AGO**

Fabric #022  
17oz Heatstop  
Information on page 38





**AGO** Fabric #027  
35oz Agotex # 1200  
Information on page 42



**AGO** Fabric #028  
40oz Agotex # 1500  
Information on page 43



**AGO** Fabric #029  
60oz Agotex # 2000  
Information on page 44



**AGO** Fabric #030  
31oz Agotex Plus # 1000-P  
Information on page 45



**AGO** Fabric #023  
32oz Heatstop  
Information on page 38



**AGO** Fabric #024  
18oz Agotex # 600  
Information on page 39



**AGO** Fabric #025  
24oz Agotex # 800  
Information on page 40



**AGO** Fabric #026  
30oz Agotex # 1000  
Information on page 41





**AGO** Fabric #032  
41oz Agotex Plus # 1500-P  
Information on page 46

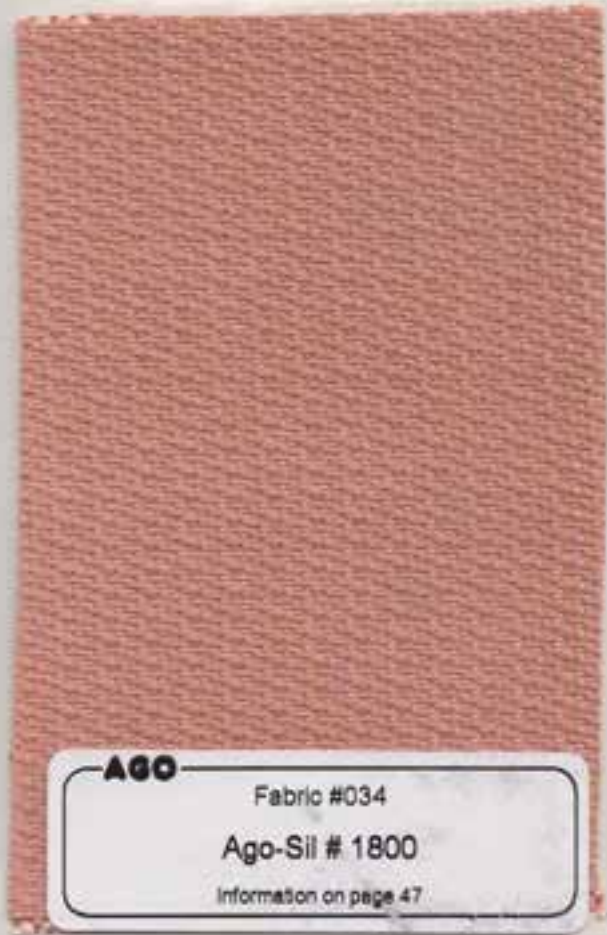

**AGO** Fabric #034  
Ago-Sil # 1800  
Information on page 47



**AGO** Fabric #035  
Ago-Sil # 3600  
Information on page 48



**AGO** Fabric #036  
Aluminized Rayon  
Information on page 70





**AGO** Fabric #037  
Aluminized Preox™  
Information on page 71



**AGO** Fabric #038  
Aluminized Aramid  
Information on page 49 and 72



**AGO** Fabric #039  
Aluminized Aramid/Carbon  
Information on page 49 and 73



**AGO** Fabric #040  
60 mil Clear Strip  
Information on page 60 and 61

**AGO**

Fabric #041

80 mil Clear Strip/Sheeting

Information on page 60 and 61

**AGO**

Fabric #042

80 mil Orange Weld Strip

Information on page 59

**AGO**

Fabric #043

80 mil Gold Weld Strip

Information on page 58

**AGO**

Fabric #044

80 mil Black Strip - Opaque

Information on page 62

**AGO**

Fabric #045

120 mil Clear Strip/Sheeting

Information on page 60 and 61

**AGO**

Fabric #046

160 mil Clear Strip/Sheeting

Information on page 60 and 61

**AGO**

Fabric #047

CG-008 Cable Cover

Information on page 52 and 53

**AGO**

Fabric #048

9oz FR Cotton

Information on page 66 and 67



**AGO**

Fabric #049

13oz INDURA® Whipcord

Information on page 68 and 69

**AGO**

Fabric #050

13oz Translucent Reinforced Vinyl/Poly

Information on page 31



**AGO**

Fabric #051

CG-002 Frame Hook

Information on page 14



**AGO**

Fabric #052

CG-001 Curtain Hook

Information on page 14

**Mailing Address:**

PO Box 7132  
London, ON  
N5Y 4J9

**Manufacturing Plant:**

500 Sovereign Rd  
London, ON  
N6M 1A4

PH: (519) 452-3780  
FX: (519) 452-3053  
EM: [mail@ago1.com](mailto:mail@ago1.com)  
WS: [www.ago1.com](http://www.ago1.com)

Catalogue

#7

Welding & Industrial Products